



# User Manual

Version 5

---

# Contents:

3	<b>Program Environment:</b> OT Draw Layout	29	<b>Working with Projects:</b> Creating a Project Working with Canvases Working with Modules
5	<b>Drawing:</b> Introduction to Drawing Drawing Parameters Drawing Tools Drawing to Scale	35	<b>Exporting Diagrams:</b> Exporting Images Transferring to Document Copy and Paste Diagrams Printing Diagrams
16	<b>Modifying Objects:</b> Selecting Objects Changing Object Parameters Manipulating Objects Duplicating Objects Arranging Objects Editing Text Creating Line-Shapes Modifying Junction Points	43	<b>Modules:</b> New Blank Canvas Bathroom Templates Floorplans Stair Designs Ramp Designs Drawing on Pictures
24	<b>Modifying the Canvas:</b> Undo and Redo Zooming and Panning Cropping and Resizing	69	<b>Support:</b> Install and Activate OT Draw Automatic Updates Support Information

# Program Environment:

## OT DRAW LAYOUT:

There are a number of key sections in the OT Draw environment. The canvas in the middle of the screen is surrounded by 4 toolbars.

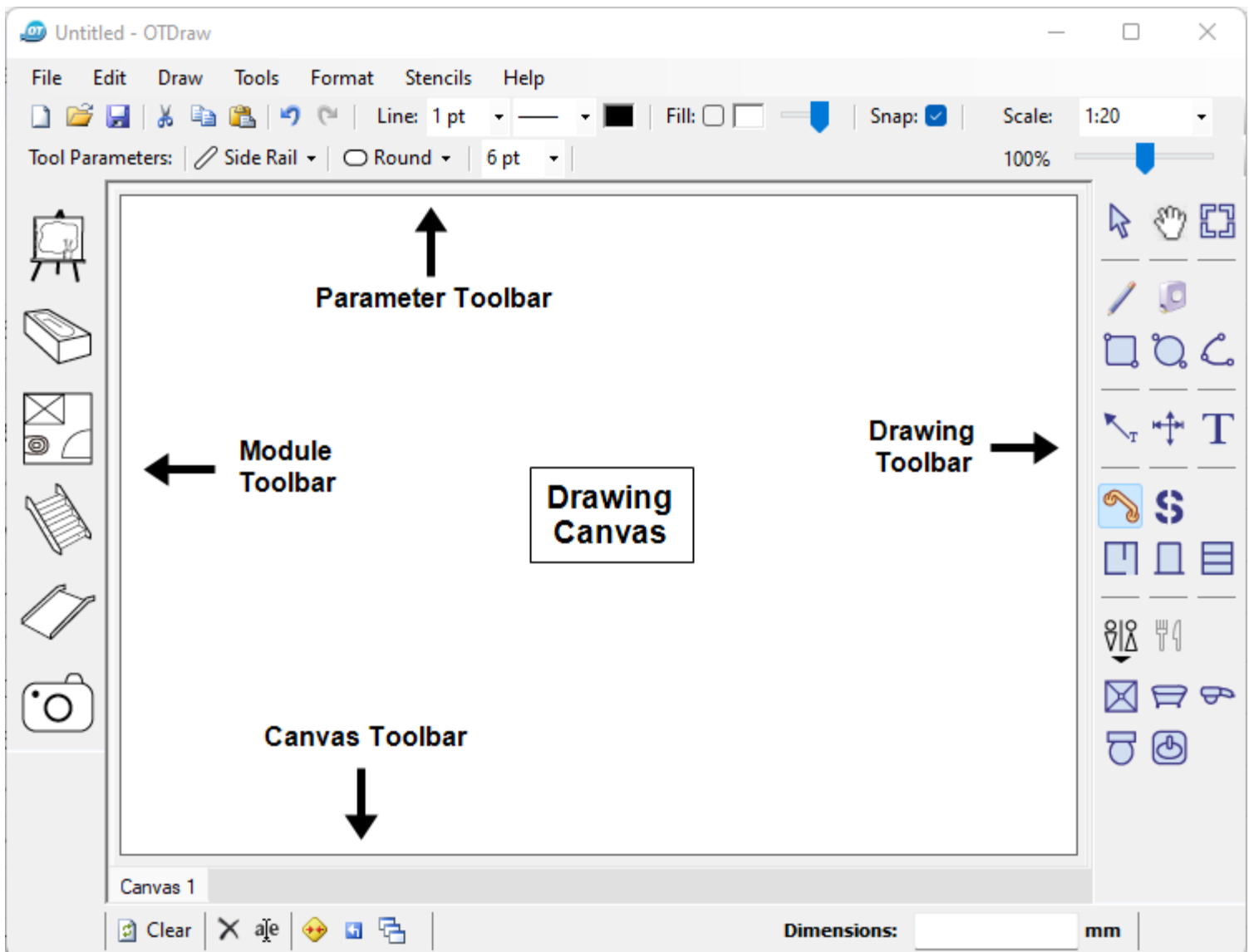

Located at the top are 7 menu items (File, Edit, Draw, Tools, Format, Stencils and Help) that contain additional features and settings.



## Toolbars:

Item	Description
Parameter Toolbar: <b>(Top)</b>	<b>Standard Parameters</b> such as project parameters and drawing parameters are shown all the time <b>Tool Specific Parameters</b> such as Rail Width and Rail End are displayed for that specific tool.
Drawing Toolbar: <b>(Right)</b>	The collection of available drawing tools including manipulation, shape, labelling, custom, room, bathroom and kitchen tools.
Canvas Toolbar: <b>(Below)</b>	Edit the canvas by clearing, deleting or renaming the canvas.
Module Toolbar: <b>(Left)</b>	Activate the different modules (ie: the different types of diagrams drawn)

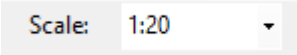
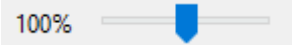
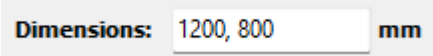
## Specific Features:

Item	Description
Scale Factor: <b>(Parameter Toolbar)</b>	Displays or changes the scale you are currently using. Parameter says 'No Scale' for perspective drawing like minor modification Bathroom Templates and for photos. 
Zoom Slider: <b>(Parameter Toolbar)</b>	Drag the Zoom Slider to zoom in and out of the diagram. Click on the percentage value to default back to 100% Scrolling the mouse wheel also performs the zoom function. 
Dimension Box: <b>(Canvas Toolbar)</b>	Displays the length or dimensions of the item being drawn. Enter dimensions while you are drawing to draw items to exact measurements. The dimension box doesn't need to be selected, the values will be displayed automatically. 
Canvas Parameters: <b>(Canvas Toolbar)</b>	These are settings specific to the canvas you are in. They are mainly associated with the Bathroom Floorplans Module. For example: 

## INTRODUCTION TO DRAWING:

---

### Drawing Toolbar:

There are 27 Drawing Tools in this toolbar. These drawing tools are split into the following groups:

Group	Drawing Tools
Manipulation Tools:	Select Tool, Hand Tool and Crop Tool.
Shape Tools:	Line Tool, Curve Tool, Square Tool and Oval Tool.
Labelling Tools:	Arrow Tool, Dimensions Tool and Text Tool.
Room Tools:	Wall Tool, Door & Window Tool and Cabinetry Tool
Bathroom Tools:	Shower Tool, Toilet Tool, Bath Tool, Basin Tool and Fittings Tool.
Kitchen Tools:	Fridge Tool, Oven Tool, Microwave Tool, Dishwasher Tool, Stovetop Tool and Sink Tool.
Additional Tools:	Measurement Tool, Rail Tool and Stencil Tool.

Hovering over the tool button will display the name and Shortcut Key for that Drawing Tool.

Right Clicking on the Tool button will bring up the tool description and features.

Click on the room type buttons to switch between Bathroom and Kitchen Tools.



## How to Draw:

Objects are drawn via 2 methods. The Click and Click method can be disabled from the Draw menu.

Click and Click: Click the mouse to start  
Move the mouse to draw  
Click again to finish.

Click and Drag: Click and hold mouse start  
Drag the mouse to draw  
Release mouse to finish.

## Drawing Tool Categories:

Drawing Tools can also be categorised as Line-Based, Rectangle-Based or Text-Based.

Category	Drawing Tools
Line-Based Objects:	Line Tool, Curve Tool, Arrow Tool, Dimension Tool, Measure Tool and Rail Tool
Rectangle-Based Objects:	Square Tool, Oval Tool, Bathroom Tools, Kitchen Tools, Wall Tool, Door and Windows Tool and Cabinetry Tools.
Text-Based Objects:	Text Tool and auto-text from Arrow and Dimension Tools.

## Shift-Key Effect:

Hold down the SHIFT key while drawing a Line-Based item to draw either vertical, horizontal or at a 45° angle.

Hold down the SHIFT key while drawing a Rectangle-Based item to draw a perfect square (for Shape Tools) or to correct proportions (Bathroom Tools)

## Snapping:

If the snapping parameter is turned on, new items will snap to the ends of line-based objects and to the corners of rectangle based objects.

## Cross-Referencing:

While on a blue snap point, tap the 'X' key to create a red reference point. The new object will now snap to anywhere on the X or Y-axis from this point.

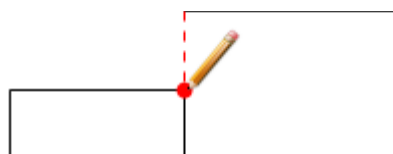

## DRAWING PARAMETERS:

---

### Project Parameters:

There are a number of project parameters that activate project commands. They are visible all the time. These parameters are:

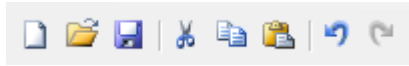

Parameter	Description
New:	Creates a new OT Draw project.
Open:	Opens an existing OT Draw project.
Save:	Saves the OT Draw project in current location.
Cut, Copy & Paste:	Used to remove, duplicate and relocate objects.
Undo and Redo:	Used to undo and redo drawing actions.

### Standard Drawing Parameters:

There are a number of standard parameters that will apply across most of the objects you draw. They are visible all the time.

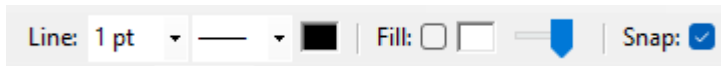

Parameter	Description
Line Width:	Determines the width of the lines in the object.
Line Style:	Determines whether the line is solid, dashed or dotted.
Line Colour:	Determines the colour of the lines in the object.
Fill Decider:	Determines whether the object is filled in or is transparent. <b>Shortcut Key = 'F'</b>
Fill Colour:	If the Fill Decider is set to true then this determines the internal or fill colour of the object.
Fill Opacity:	Slide the Opacity Slider to keep the fill colour but make it partially see-through
Snapping:	Determines whether the drawing tool will 'snap' to the end of the ends and corners of objects in the diagram. <b>Shortcut Key = 'N'</b>

## Text Parameters:

These parameters apply to the text based labelling tools ie, the Text, Arrow and Dimension Tools. These parameters are visible when drawing or editing text.

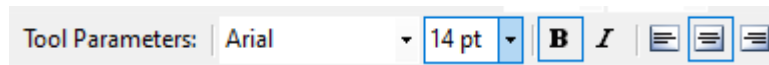

Parameter	Description
Font Name:	Determines the type of font that will be used.
Font Size:	Determines the size of the font that will be used.
Bold:	Determines whether the font will be <b>Bold</b> .
Italic:	Determines whether the font will be <i>Italic</i> .
Font Alignment:	Determines whether the font will be aligned left, aligned right or centred.

## Specific Parameters:

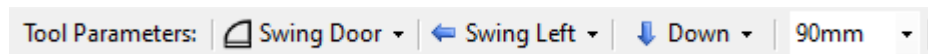



There are a number of specific parameters that will only become visible when a certain Drawing Tool has been selected. These parameters include things such as the size of the arrowheads, direction of the drawing item or different types of the drawing object. All these parameters are outlined in the sections below.







## DRAWING TOOLS:

---



### Manipulation Tools:

Tool	Description
 Select Tool: [space]	Selects objects to then move, modify, resize, arrange, copy and delete them.
 Hand Tool: [H]	Moves all the objects in the diagram. Use this tool to pan around the canvas.



### Shape Tools:

Tool	Description
 Line Tool: [L]	<p>Draws a straight line by 'Click and Clicking' or 'Click and Dragging' on the canvas.</p> <p>While drawing tap the 'L' key (Click and Drag) or right mouse click (Click and Click) to draw multiple lines that form a <b>Line-Shape</b> (see page 22 for more details).</p>
 Curve Tool: [C]	<p>Draws either an arc or a curve.</p> <p>For an Arc 'Click and Drag' a line and then tap the 'C' key to pull out a smooth arc between those points. Alternatively 'Click and Click' a line, then pull out the arc and click again to finish.</p> <p>The Curve option draws a curve shape through a series of points. While drawing tap the 'C' key (Click and Drag) or right mouse click (Click and Click) to add points in the curve.</p>
 Square Tool: [S]	<p>Draws a rectangle by 'Click and Clicking' or 'Click and Dragging' on the canvas.</p> <p>Can be drawn as standard or as a rounded rectangle.</p>
 Oval Tool: [O]	Draws an oval by 'Click and Clicking' or 'Click and Dragging' on the canvas.





## Label Tools:

Tool	Description	Specific Parameters	Parameters Details
 Arrow Tool: [A]	Draws an arrow by 'Click and Clicking' or 'Click and Dragging' on the diagram.	Arrowhead size Direction of arrow Auto Insert Text	The Auto-Insert-Text parameter will make a textbox automatically appear up for you to label your diagram
 Text Tool: [T]	Click on the canvas to display the textbox. Enter text and then click outside the textbox to insert the text on the diagram. Press ESC to cancel the textbox.	Direction of text	The text direction can be set to rotate the text to different orientations  <b>Down</b> <b>Left</b> <b>DN</b> <b>Right</b>
 Dimension Tool: [D]	Draws a dimension line by 'Click and Clicking' or 'Click and Dragging'.  The tool will then automatically switch to the slide away from the object	Ending Types Auto Insert Text Text Parameters	The Auto-Insert-Text parameter will make the length of the dimension be automatically inserted with the dimension line

## Room Tools:

Tool	Description	Specific Parameters	Parameters Details
 Wall Tool:	Manually draws single wall, multiple walls or Wall Lineshape  See pages 50-52 for drawing techniques	Number of walls Direction of wall shape Wall Width	The direction for '2 Walls' is the diagonal of the intersection  The direction for '3 walls' is the location of the centre wall
 Door and Window Tool: [Alt+D]	Draws swing doors, sliders, window tops and side views of windows and doors.  Use Arrow keys to change the Door direction while drawing.	Door Type Door Swing Door Direction Door Width	Tap the TAB key to alternate between Door Swing options.  The direction is the way door opens into the room  The Door Width corresponds to the width of the wall so it is blocked out correctly.
 Cabinetry Tool:	Draws Drawers and Cupboards  A kickboard can be added to both options Cupboards can be drawn in front, top or side views	Number of drawers Cupboard Orientation Cupboard Style Handle Options Kickboard height	Check the kickboard box to enter the kickboard height  By default, the drawers will be drawn with uniform heights. Once they are drawn, select and right click on them to edit individual drawer heights.

## Bathroom Tools:

Tool	Description	Specific Parameters	Parameters Details
	Shower Tool [Alt+S] Draws a shower recess Tap the TAB key to alternate between Hob Options.	Hob Options	
	Toilet Tool [Alt+T] Draws a toilet object. Tap the TAB key to alternate between Draw Start Point. Tap the Arrow keys to change the Toilet direction while drawing.	Start Point Toilet Direction Toilet Orientation	The toilet can be drawn From Edge or From Midline. The latter option is designed to assist with drawing the toilet a certain distance from the side wall to the centre of the toilet.
	Bath Tool [Alt+B] Draws a bath object. Use the Arrow keys to change the Bath Direction while drawing.	Bath Direction Bath Orientation	
	Basin Tool [Alt+V] Draws a vanity, wall basin or corner basin. Tap the TAB key to scroll through these options. Use the Arrow keys to change the Basin Direction while drawing.	Basin Type Basin Direction Basin Orientation	The 4 Basin Types: Vanity, Wall Basin, Corner Basin and Bench will change the appearance of the floorplan but will also affect the look of the corresponding side view.
	Fittings Tool [Alt+F] Draws a bathroom or wall fitting by 'Click and Click' or 'Click and Dragging'. Use the Arrow keys to change the Fitting direction while drawing.	Fitting Type Direction of Item	Select between 3 shower head options, 3 tap options or 2 wall fittings





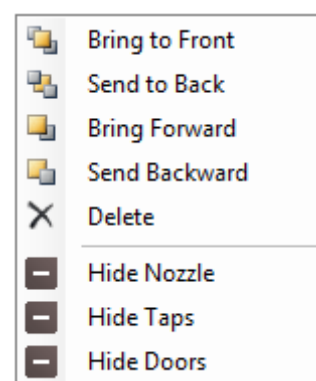

When drawing a bath, vanity, wall basin or corner basin they are initially drawn with taps and a nozzle. However by selecting and right clicking the object you can hide the taps or nozzle. Right-click again to re-show the feature.

When you create a side-view (see Pages 54-56) the corresponding object will also be displayed with taps or nozzle hidden.

When a side-view of a vanity has been created, it is initially drawn with cupboard doors. These can also be removed by selecting the vanity and right-clicking.





## Kitchen Tools:

Tool	Description	Specific Parameters	Parameters Details
	<p>Fridge Tool</p> <p>Draws a fridge object from 4 different styles.</p> <p>Fridge can be drawn from front, side or top view.</p> <p>In top view, tap the Arrow keys to change the Fridge direction while drawing.</p>	<p>Fridge Style</p> <p>Door Swing</p> <p>Fridge Direction</p> <p>Fridge Orientation</p>	<p>In front view and top view, the door swing can be changed. This changes the handle location. Tap the TAB key to switch this swing.</p>
	<p>Oven Tool</p> <p>Draws an oven object.</p> <p>Tap the TAB key to switch between door swing options.</p>	<p>Door Swing</p>	<p>This tool has the option for oven door to swing left, right or down.</p>
	<p>Microwave Tool</p> <p>Draws a microwave object.</p> <p>Only available in front view.</p>		
	<p>Dishwasher Tool</p> <p>Draws a dishwasher object.</p> <p>Only available in front view.</p>		
	<p>Stovetop Tool</p> <p>Draws a stovetop in top view with 5, 4 or 2 burner configurations.</p> <p>Tap the Arrow keys to change the Stovetop direction while drawing.</p>	<p>Number of Burner</p> <p>Direction of Item</p> <p>Knobs Displayed</p>	
	<p>Sink Tool</p> <p>Draws a sink object in top view with single or double bowl configurations.</p> <p>There is also the option to include drainer or not.</p>	<p>Sink Style</p> <p>Bowl Location</p> <p>Sink Direction</p>	

## Additional Tools:

Tool	Description	Specific Parameters	Parameter Details
 Rail Tool (Side View) [R]	<p>Draws a side rail through a series of points.</p> <p>While drawing tap the 'R' key (Click and Drag) or right mouse click (Click and Click) to add junction points for the rail.</p> <p>Tap the TAB key to alternate between Rail End Options.</p>	<p>Rail View</p> <p>Rail End Options</p> <p>Rail Width</p>	<p>The Side View is a curved rectangle to represent a rail placed on a wall.</p> <p>The Rail End parameter can be set to Round End, Square End or Flange End</p>

## Additional Tools (con't):

Tool	Description	Specific Parameters	Parameter Details
 Rail Tool (Top and Corner View) [R]	Draws a top-view rail by 'Click and Click' or 'Click and Dragging'. Use the Arrow keys to change the Rail direction while drawing.	Rail View Rail Direction	The Top View and Corner View are both designed to be used with in the Bathroom Floorplan module. They operate like the other Bathroom Drawing Tools and have a direction that can be changed. This direction is determined by the Rail Direction parameter.
 Measure Tool: [M]	Measure the distance between 2 points on the canvas based on the Scale Factor. Tap the 'M' key before releasing the mouse or enter a distance to create a snap point to draw from.		
 Stencil Tool [Alt+X]	Draws custom Stencils by 'Click and Click' or 'Click and Dragging'.	Stencil List	This is the list of default and custom stencils available for you to use

## Creating Stencils:

To create a custom stencil perform the following steps:

1. Clear any canvas
2. Draw the desired stencil using any of the drawing tools
3. Go to the Stencil menu and click Create Stencil
4. Name the stencil and give it a starting direction (if applicable)
5. Choose to save it in default location or in another location (eg: network drive)
6. Click Create to Finish
7. The new stencil is now in your Stencil List in the Stencil Tool.

## Importing and Exporting Stencils:

Your stencils can be stored in a custom folder to be shared amongst your team (eg: in a network drive).

To import any stencils saved in this location, go to the Stencils menu and click Import Stencils. Find the custom folder and click Open.

To export any of your previously created stencils, go to the Stencils menu and click Export Stencils. Please note: New stencils can be saved directly to this new folder (see above).

## DRAWING TO SCALE:

---

### Scale Factor:

The Scale Factor textbox displays the current drawing scale. The default scale is 1:20. The Scale Factor is disabled for the Bathroom Templates and Picture Design modules as these are not drawn to scale. It is possible to set the relative scale for Picture Designs as outlined below.

**Please note:**

The diagram is set to the right scale on the computer screen. However when you export or print the image, the image size needs to be 100% to remain at that scale.

### Unit Settings:

The length and dimensions of the objects can be displayed in millimetres (mm), inches (in) or feet and inches (ft, in).

Change these unit settings by going to the Format menu and selecting Unit Settings, or by double clicking the label beside the Dimension Box.

### Reading the dimension as you draw:

The Dimension Box in the bottom right corner displays the length or dimensions of the object. The length is displayed as a single value for any line-based object. The horizontal and vertical dimensions are displayed as two values separated by a comma for any rectangle-based object.

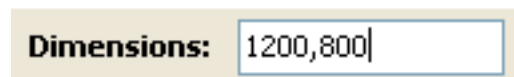
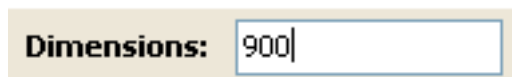

### Entering the dimension as you draw:

Exact dimensions of an object can be entered while drawing.

When drawing by 'Click and Click' type in the dimensions and press Enter.

When drawing by 'Click and Drag' type in the dimensions and then release the mouse to finish.

Please note: the Dimension Box does not need to be selected or highlighted. The dimensions will automatically be displayed here as you type them.

For line-based objects type the length and the object will appear in the same direction at the length you determined.

For rectangle-based objects type in the width value, then a comma, and then height value. It will then draw the object in the same direction with the dimensions you determined. If a single value is entered the object will be drawn with that same width and height.

## Tapping 'E' key as you draw:

To avoid having to hold down the mouse and enter the dimensions as you draw, there is an option to tap the 'E' key while drawing instead. (E for Enter)

As with entering dimensions, you need to start drawing the object to give it a start point and direction, and then tap the 'E' key.

This will bring up a popup window with fields to enter. Once the popup window appears you can let go of the mouse to enter the length or width and height in the fields.

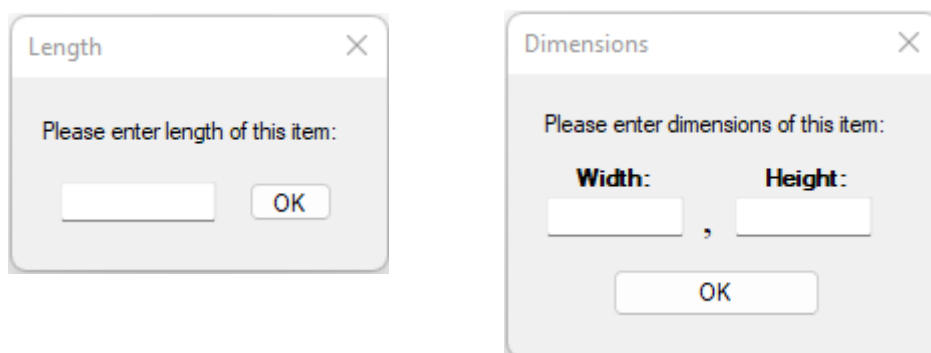

## Dimensions while selecting:

When an object is selected and current length or dimensions are shown in the Dimension Box.

When resizing the selected object the new dimensions can be entered just like when objects are initially drawn to scale.

If only the width or height of an object is being resized, type in a single value for that width or height.

When rotating an object, the angle is displayed in the Dimension Box. Rotate the object to an exact angle by typing in the angle value and pressing Enter.

When a selected object is being moved the Dimension Box will show how far the objects have moved from their original location.

## Setting the Relative Scale for Picture Designs:

See '**Module: Picture Designs**' section for more information on using this feature. This module allows the insertion of a picture or photo to draw on. This means that the scale for this picture is meaningless because it is impossible to know the size of whatever is in the picture.

However it is possible to set a relative scale for the picture. Start by selecting the Measure Tool and measuring something in the picture that has a precise measurement (eg: the height of a step). Enter this value in the Dimension Box and press enter. The scale is now set to this ratio.

**Please note:** This is not an exact scale as the picture will have varying depths which affects the true scale of that part of the picture. However it will make the scale more comparable.

# Modifying Objects:

## SELECTING OBJECTS:

---

Selecting is the ability to highlight an object or several objects in order to move, change or edit them. Selecting an object changes its colour to red and creates markers in order to move and resize it.

### How to Select:

Select and deselect in the following ways:

Method	Description
Click to Select:	Click the Select Tool and then click the object. It will select the top most object. Hold down the SHIFT key while selecting items to select more than one object. Deselect objects by clicking them again.
Select Box:	Click and drag a select box around the objects you wish to select. An object will only be selected if the whole object is within the select box. This option is only active when no objects are currently selected.
Select All:	Select all the objects on your canvas by using the Select All command in the Edit menu. Ctrl-A will perform the same function.
Deselect:	Pressing the ESC key will deselect all objects.



## Operations that may be performed on selected objects:

No of Objects	Operations	Functions
1 Object Selected:	Features:	Change Parameters
	Manipulate:	Move Resize Rotate Delete
	Duplicate:	Cut Copy Paste
	Arrange:	Bring to Front Bring Forwards Send to Back Send Backwards
	Text:	Edit Text
2 or More Objects Selected:	Features:	Change Parameters
	Manipulate:	Move Delete
	Duplicate:	Cut Copy Paste

## CHANGING OBJECT PARAMETERS:

If an object is selected, its current parameters will be shown in the parameter bar.

When any object (Line, Rectangle or Text Based) is selected, change its features simply by changing the parameters. For instance, if a Line object is selected, change the width from 1px to 5px by changing the Line-Width parameter.

In the same way, change an object's line colour and fill colour, as well as change the text font, size and style.

Adjust the specific parameters of an object to change its appearance. For instance, change the size of the arrowhead for dimensions and change the direction of toilets and other bathroom objects.

## MANIPULATING OBJECTS:

---

After selecting objects it is then possible to move and manipulate them within your diagram.

### Moving Objects:

To move a selected object, hover over the centre of the object until the cursor becomes a 4 point arrow. Then click and drag to move the object. The movement away from the original point will be shown in the Dimension Box.

#### **SHIFT key:**

Hold down the SHIFT key while moving the object to move in a horizontal or vertical plane.

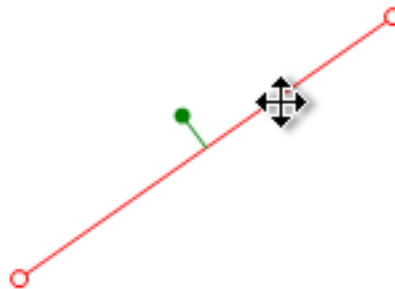

### Resizing Objects:

To resize the object click and drag the markers at the end of the line-based object or at the corners of the rectangle-based object.

#### **SHIFT Key:**

Holding down the SHIFT key while resizing will result in the following:

*Line-based object:* The line retains in the same direction.

*Rectangle-based object:* The rectangle retains the same horizontal and vertical proportions.



## Rotating Objects:

To rotate an object, click and drag on the green circle. The object will rotate as the cursor is moved around the object.

**SHIFT key:**

Holding down the SHIFT key while rotating the object will make it snap to 45° angles.



## Deleting Objects:

While objects are selected, delete them in the following ways:

1. Tap the Delete or Backspace keys
2. Right-click the canvas to bring up the context-menu and select the Delete option.

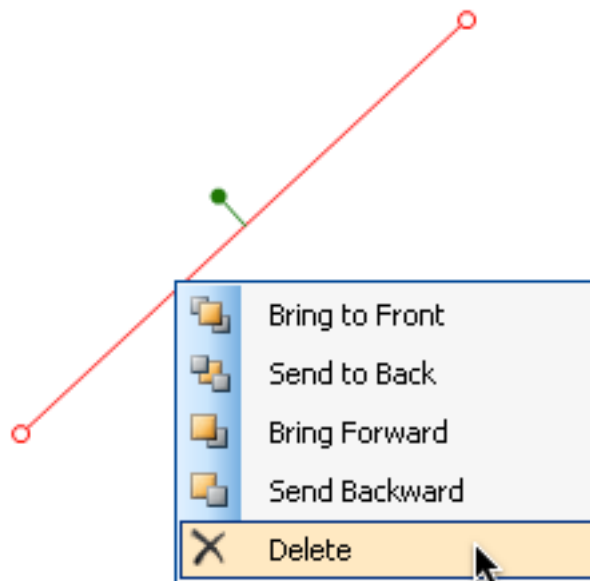

## DUPLICATING OBJECTS:

---

Duplicate objects by using the Cut, Copy and Paste commands. These can be accessed in 3 ways:

1. Click the Cut, Copy and Paste buttons in the Parameter Bar
2. Select them in the Edit Menu
3. Use the shortcut keys of Ctrl+X (Cut), Ctrl+C (Copy) and Ctrl+V (Paste)



Cutting or copying an object allows it to be pasted elsewhere in the project, including in different canvases. When the object is pasted, it is placed directly over the original. Move the object if it is required in a different location.

## ARRANGING OBJECTS:

---

### Arrangement Commands:

All the objects are layered depending on when they were drawn. When a new object is added it is drawn on top of the layers. Rearrange these layers to change the layout using the following commands:

<b>Command</b>	<b>Description</b>
Bring to Front:	Brings the object in front of all other objects.
Send to Back:	Sends the object behind all other objects.
Bring Forward:	Brings the object up one layer.
Send Backward:	Sends the object down one layer.

## Rearranging Diagram Layers:

Access these arrangement commands by right-clicking the canvas when a single object is selected. Then select the required option from the context menu.

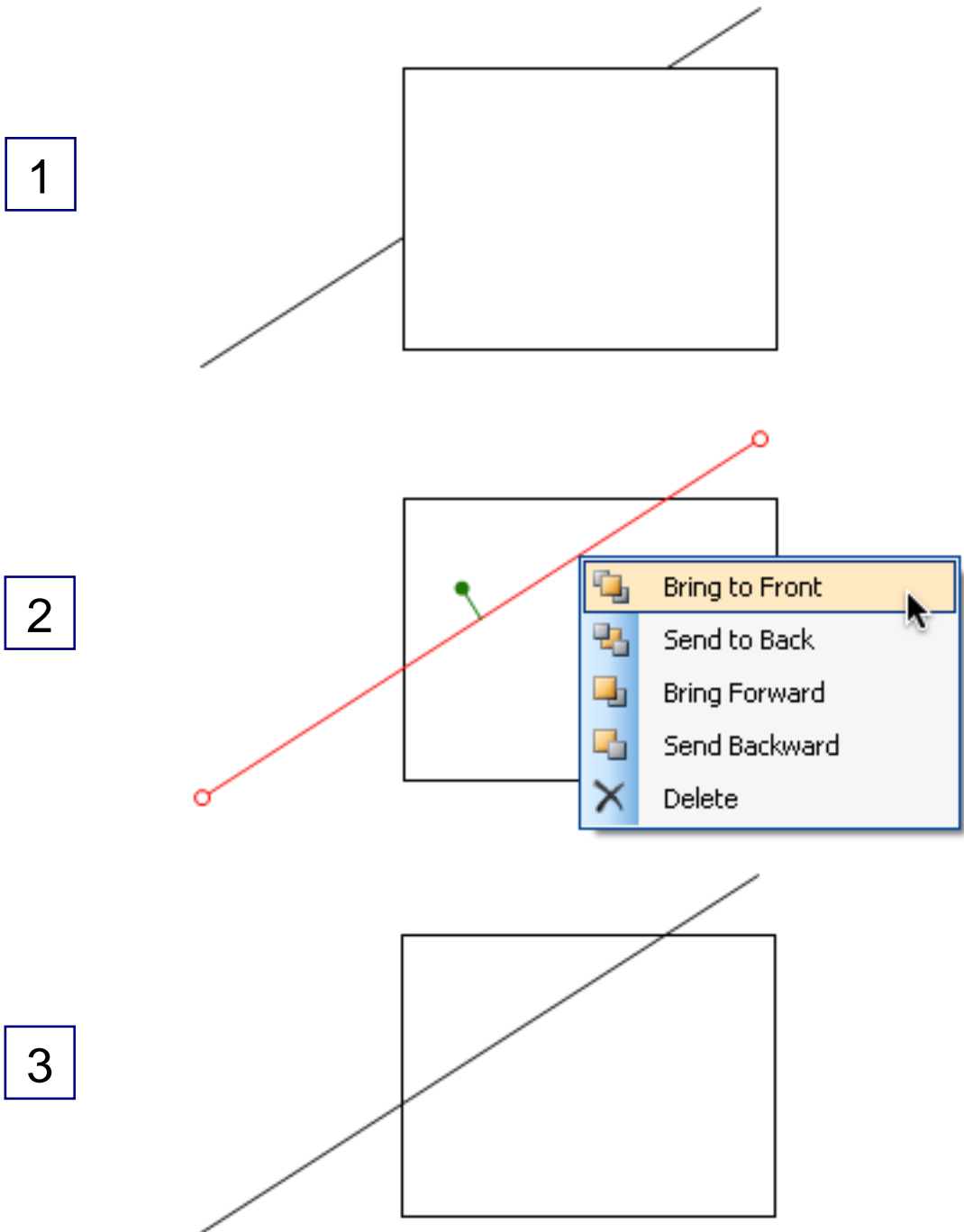

## EDITING TEXT:

---

Change the words in a text object at any time by using the Edit Text command. Select the text object, then either **click the text object again** or right-click the canvas and select the Edit Text command.

This will reshove the textbox to change the text value. Click outside the textbox to insert your new text or press ESC to cancel and retain the existing text.

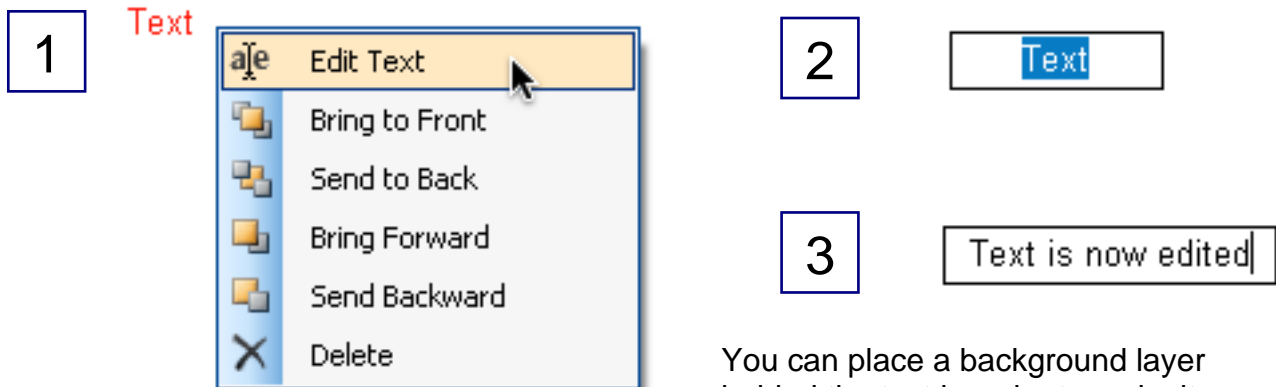

You can place a background layer behind the text in order to make it stand out on the diagram. After the text has been drawn, select the text, then choose your Fill colour and check the Fill checkbox.

Normal Text      Text with Background Layer

**Please note:**

Use the 'Select All Text' command in the Format menu to select all the text in the canvas at once.

## CREATING LINE-SHAPES:

---

A line-shape is an object made of connected lines. It can have up to 12 sides and can have a fill-colour. There are 2 ways to create a line-shape:

1. While drawing with the Line Tool, tap the 'L' key (Click and Drag) or right-click mouse (Click and Click) to create junction points in the line-shape. When the mouse is released a single object is created.
2. Select a series of connected lines and select the 'Create Lineshape' command in the Format menu. This command is only visible when a collection of lines is selected.

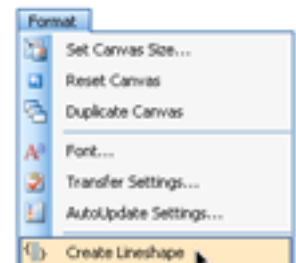

**Please note:**

A line-shape can be broken down into separate lines by selecting the 'Separate Lineshape' in the Format menu.

## MODIFYING JUNCTION POINTS:

---

There are 3 objects that contain junction points: Line-Shapes, Curves and Rails. When these objects are selected it is possible to add or remove junction points.

These commands are accessed by selecting an object with junction points and right-clicking the mouse. The following context-menu is displayed:

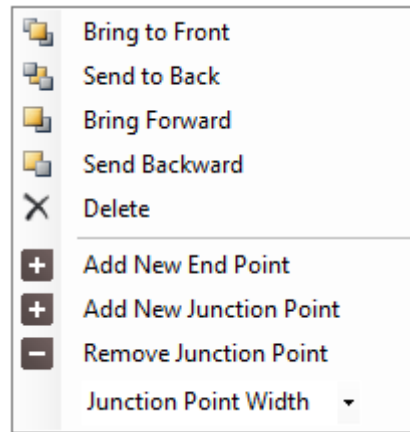

### Add Junction Point:

When the object is selected, add an additional junction point by right-clicking and selecting the appropriate command.

Select either Add New End Point to add a junction point to the end of the object or Add New Junction Point to add a point to the middle.

The additional junction point is added to the object at the location where the mouse was clicked.

### Remove Junction Point:

To remove a junction point, right-click the object and select the Remove Junction Point command.

The junction point nearest to the click point is removed.

### Change Junction Point Width:

For junction points on rails, the width of the rail can be changed for individual junction points. This is helpful in showing perspective. To do this, select the rail and then right-click on the junction point you want to change and change the width in the context menu provided.

# Modifying the Canvas

## UNDO AND REDO:

---

Undo and redo are powerful operations for modifying your diagram. Each canvas has its own undo and redo operations, allowing undo and redo options to occur between canvases.



Operate the undo and redo commands in the following ways:

- Use the buttons in the Parameter Bar
- Select the options in the Edit menu
- Use the shortcuts Ctrl+Z (undo) and Ctrl+Y (redo)

## ZOOMING AND PANNING:

---

### Zooming:

Zoom and Pan change the view of the diagram. These features are built into other features.

Zoom is different to Scale. Changing the Scale also changes how the dimension box represent distances on the canvas. Zooming in and out allows you to draw more precisely at different sections of the canvas. However when you export the diagram it will return to the designated scale.



## Zooming Methods:

There are 4 ways to zoom in and out on the canvas:

1. Drag the Zoom Slider underneath the Scale Factor in top right hand corner. Clicking on the Zoom Label (eg: 70%) will return diagram to original 100% zoom.
2. Scroll the mouse wheel while cursor is on canvas to zoom in and out. This will zoom towards the point where the cursor is located.
3. Under the Tools Menu select either the Zoom-In or Zoom-Out options or use the Ctrl + Minus or Ctrl + Plus shortcuts.

## Panning:

Panning is the ability to move the diagram around on the canvas. Do this by clicking the mouse wheel like a button and then clicking and dragging. Alternatively use the Hand Tool to left-click and drag the diagram to a new location. The amount that the diagram has been moved can be seen in the Dimension Box.

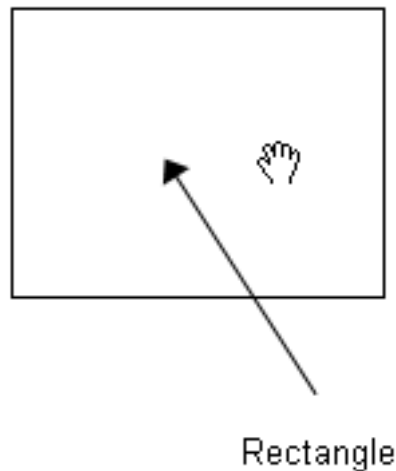

## CROPPING AND RESIZING THE CANVAS:

---

### Crop the Canvas:

After drawing a diagram it is possible to crop your diagram to decrease to amount of white space around it. There are 2 ways to crop the diagram: Auto-Crop and Manual Crop.

#### **Auto-Crop:**

When exporting your diagram (see Page 35) the Auto-Crop feature will automatically remove the white space so it fits better in the document. The Auto-Crop feature can be turned on and off by going to Transfer Settings in the Format menu.

#### **Manual Crop:**

To manually crop an image go to the Crop Tool and using the left mouse button, click and drag boundary lines around the diagram. Adjust these boundary lines to the exact spot you wish to crop. Then while the boundary lines are showing press ENTER to crop the diagram. To cancel the boundary lines press ESC and they will disappear.

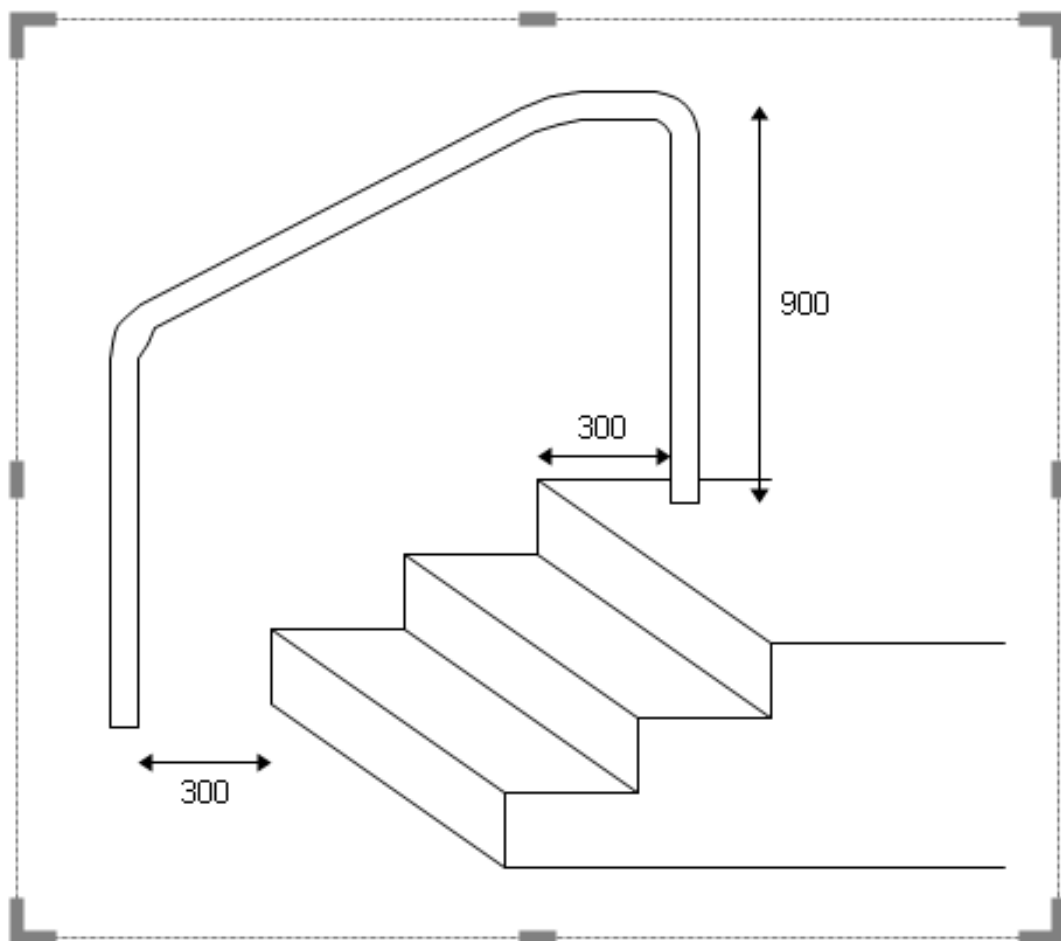

## Resize The Canvas:

Using the Crop Tool can only make the image smaller. However, it is possible to also make the image bigger. To do this, select the Set Canvas Size command in the Format menu.

You are offered 2 ways to resize the image:

1. Set the exact pixel size of the image
2. Set the new size as a percentage of the existing size

Locking the ratio will constrain the height and width proportions.

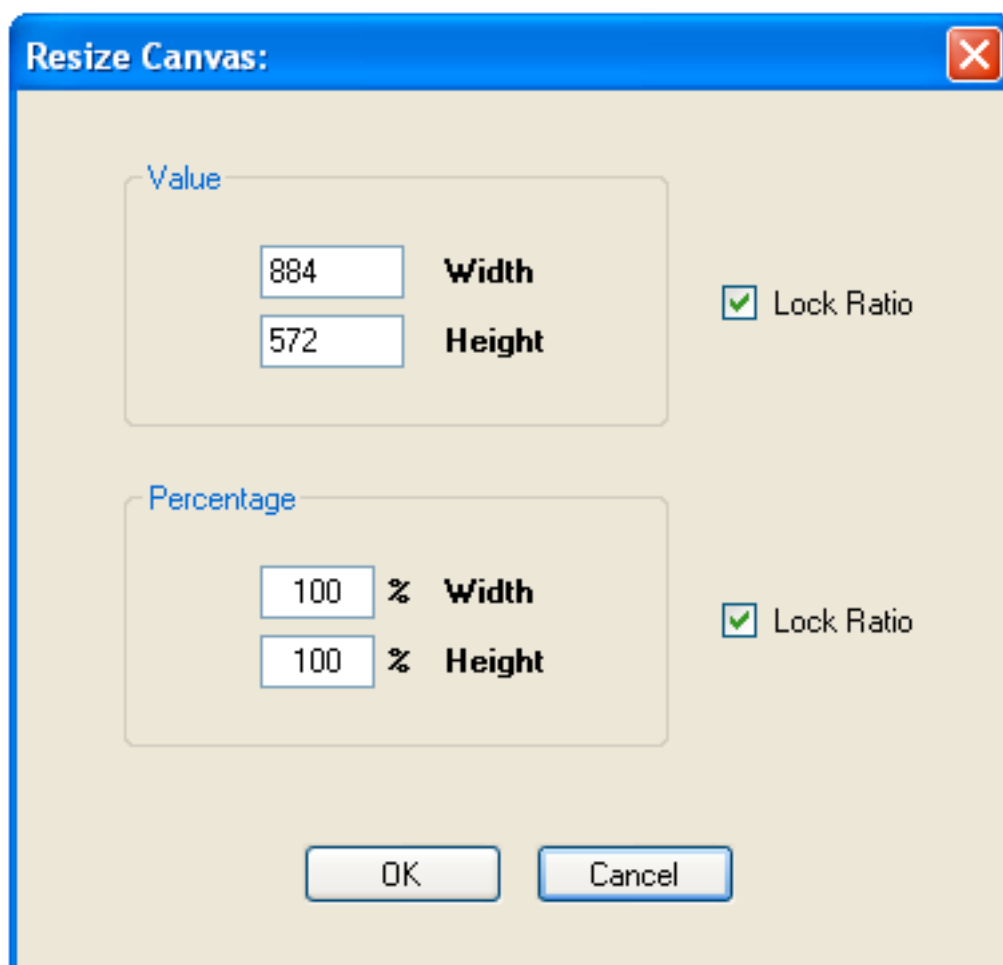

Using this feature allows the image to be smaller or larger than the existing one. When making it larger the canvas will create scrollbars in order to see the whole image.

You don't necessarily have to increase the size of the canvas though. If your diagram extends past the borders of the canvas, OT Draw will ask if you want to include the whole diagram when you export it.

## Reset the Canvas:

To return the diagram to the full size of the canvas you must reset the canvas.

Access the Reset Canvas command in the following ways:

1. Go to the Format menu and select Reset Canvas
2. Select the Edit Canvas button in the Canvas Toolbar and select Reset Canvas.

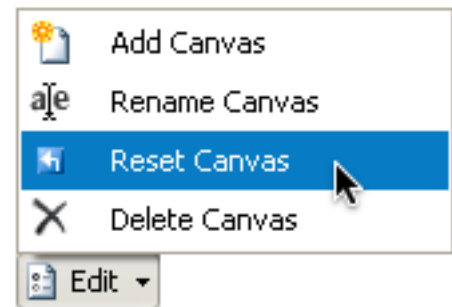
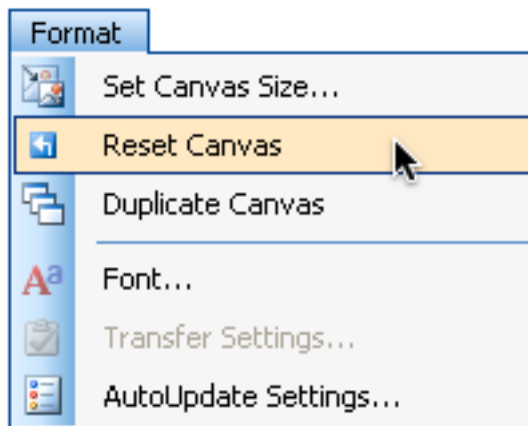

# Working with Projects

## CREATING AN OT DRAW PROJECT:

---

The canvas is the drawing section of OT Draw. However, it is possible to have multiple canvases so that different OT diagrams can be created for the same client. The collection of these diagrams is called an OT Draw Project.



### Creating a Project:

When OT Draw is first opened a new empty Project called 'Untitled' is created. If a Project is already open, start a new Project by:

- Clicking the New parameter
- Going to File → New
- Using the shortcut Ctrl+N

### Saving a Project:

An OT Draw project is able to be saved so that additional diagrams or changes to existing diagrams can be made at a future date. A project is saved by:

- Clicking the Save parameter
- Going to File → Save Project
- Using the shortcut Ctrl+S

If the project hasn't previously been saved then a dialog box will appear asking for a project name and location to be entered. If the project has previously been saved then it will simply be re-saved in that same location.

The project can be saved under a new name by using the Save Project As command in the File menu. This option might be used to create different projects for different stages in the home modification application.



## Opening a Project:

An existing project can be opened to make additions or amendments. OT Draw Projects are saved with a file extension of .otd (eg: MyProject.otd). This .otd file can be opened by:

- Clicking on the Open parameter
- Going to File → Open
- Using the shortcut Ctrl+O

A project can also be opened by double-clicking the project icon in the location where it is saved. This will automatically open OT Draw along with this project.

## WORKING WITH CANVASES:

---

An OT Draw Project can have multiple canvases reflecting the multiple diagrams saved in the project. Each canvas is represented by a Tab at the bottom of the canvas. The canvas name is identified by the Tab label.

The Canvas Toolbar has commands to edit and format the canvases. The canvas can be edited by clicking the parameters below the canvas or by right clicking any of the tabs and selecting from the context menu.

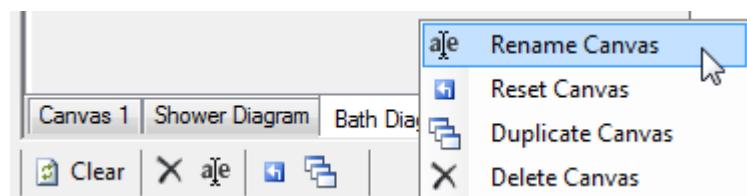

The canvas settings include clearing, deleting, renaming, resetting and duplicating the canvas.

## Clearing the Canvas:

At any point clicking the Clear Canvas button will clear the current canvas. This will wipe the canvas clean to start a new diagram.

## Centring the Canvas:

This will bring your diagram to the exact centre of the canvas. This is helpful when zooming and your diagram is no longer visible.

## Resetting the Canvas:

Resetting the canvas restores the original size of the canvas. As previously mentioned the canvas can be cropped or resized to suit the diagram. To reverse that action, reset the canvas so that it fills the entire space again.

Resetting the canvas after a bathroom template or picture is inserted will do 2 things:

- Show the entire image again if it has been cropped
- Reset the zoom back to 100%

## Deleting a Canvas:

Click on the Delete Canvas button to remove a diagram from your project. A confirmation box will appear to confirm your action. Select 'Yes' to delete your canvas.

## Renaming Canvases:

Rename the different canvases to identify the types of diagrams being created. Appropriately naming the canvases will assist when exporting or transferring multiple images.

To rename the canvas select the Rename Canvas option in the Edit Canvas menu. A pop-up menu and textbox will appear. Enter the new name for the canvas and press Enter. Press ESC to exit this menu.

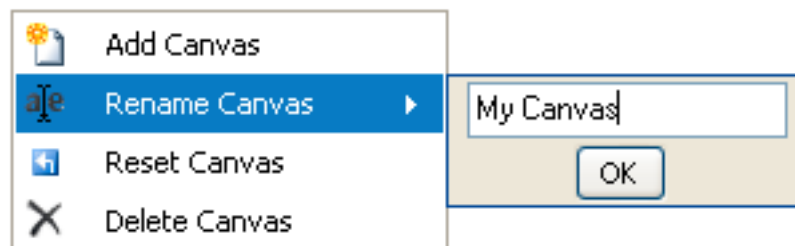

## Duplicating Canvases:

Using the Cut, Copy and Paste tools will duplicate objects but it is also possible to duplicate an entire canvas. Duplicating a canvas will create an exact replica of the existing canvas including all objects and scale settings. This is convenient when wanting to make two or more diagrams for the same recommendation. For example when drawing existing and proposed bathroom floorplans or providing different rail options for a stair diagram.

To duplicate a canvas you simply select the Duplicate Canvas option in the Format menu or the Edit Canvas menu and a replica of the current canvas will be created.

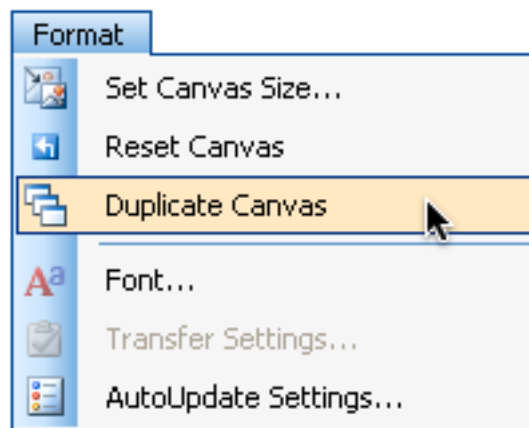

## Adding Canvases:

New canvases are added to the OT Draw project by using the Module buttons on the left toolbar. The Blank Canvas module button will add an empty canvas.

All the other modules will add a new canvas with that type of diagram already drawn.

## Reordering Tabs:

Your diagrams can be rearranged to suit your project by clicking and dragging on the tab and dragging it to a new location.

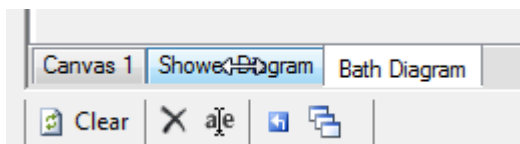



## WORKING WITH MODULES:

---

### What are Modules?

OT Draw Project has 6 different modules. Each module has an inbuilt function to assist with drawing that type of diagram. The 6 modules are:

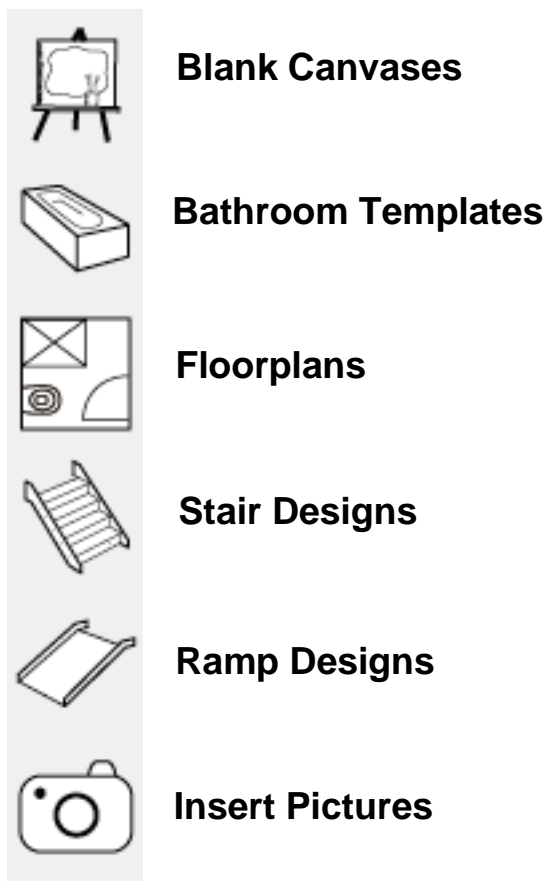

Each module OT Draw has a special inbuilt function that assists with drawing this types of diagram. See the Modules section in the manual for a full description of how these functions work.

Clicking on a module will activate this inbuilt function and then add a new canvas with that type of diagram.

## Module Functions:

The real power of OT Draw is its ability to assist with drawing specific types of OT diagrams. Each module has a specific Function Action that assists with drawing that type of diagram:

<b>Module</b>	<b>Function Action</b>
Blank Canvas	Adds a new blank canvas to your project. Use all the drawing tools to make your custom diagram.
Bathroom Template	Opens up a form of bathroom template options to insert into the diagram.
Floorplans	Opens up a form to specify the shape and size room to insert. Then based on your floorplan will create side views of the selected walls.
Stair Designs	Opens up a form to enter values for the number and size of steps and rails to draw on the canvas.
Ramp Designs	Opens up a form to enter values for the type and size of ramp, platforms and rails to draw on the canvas.
Photo Designs	Opens up dialog box to select a picture to insert on the canvas.

# Exporting Your Diagrams:

After creating diagrams in OT Draw there are 4 ways to utilise them:

1. Export Picture – export the diagram as an image to use in documents or reports
2. Transfer to Document – automatically send the diagram to a document with client details included
3. Copy and Paste – straight from OT Draw into another application
4. Print Diagram – print the diagram straight from OT Draw

## EXPORT IMAGES:

---

### Exporting:

Export the diagram from OT Draw as an image file to use elsewhere. The image will contain everything in the canvas. It is good practice to crop the image (by either Auto-Crop or Manual Crop) so that your image is only as big as the diagram.

To start exporting your diagrams:

- Select the 'Export as Image...' option from the File menu.
- If you have multiple diagrams in your project, select which diagrams you want to export.

Use the buttons and checkboxes to select:

- the current diagram
- all the diagrams
- or just some of them.

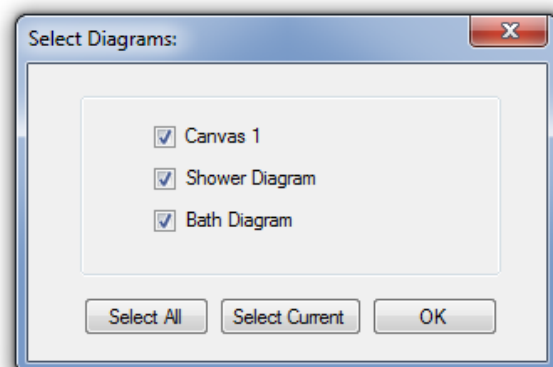

## Exporting Single Diagram:

If exporting a single image:

1. Choose a filename for the image. The default filename is the name of your canvas.
2. Select the type of image. The options are JPEG, GIF and BMP.
3. Select a location to save the image file.
4. Click Save.

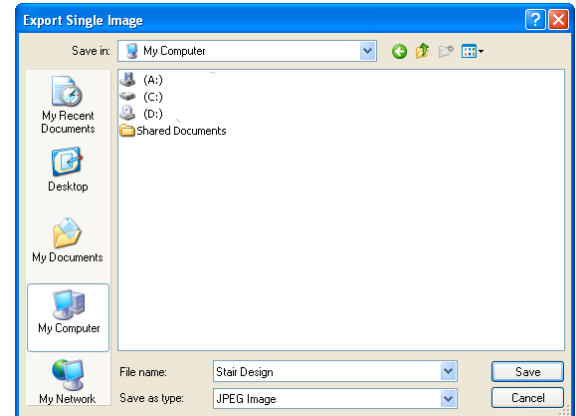

## Exporting Multiple Diagrams:

If multiple diagrams are selected it is possible to export all the images at once.

When exporting multiple images perform the following steps:

1. Select the location to store the images files and click ok.
2. Select the type of image you want to export.
3. Determine whether to store the images in a new folder and enter a folder name.
4. Click Export All.

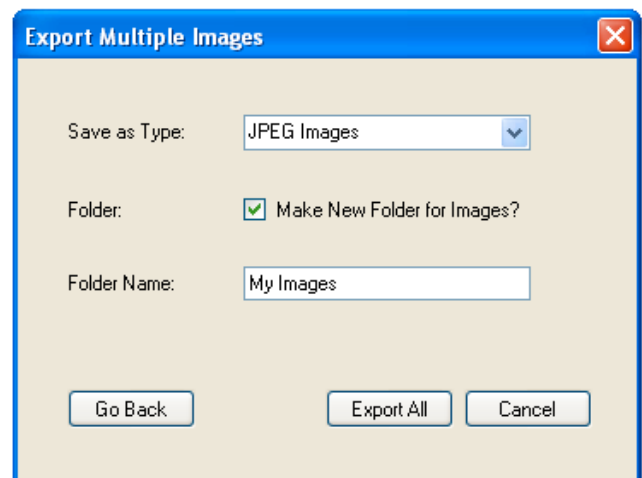
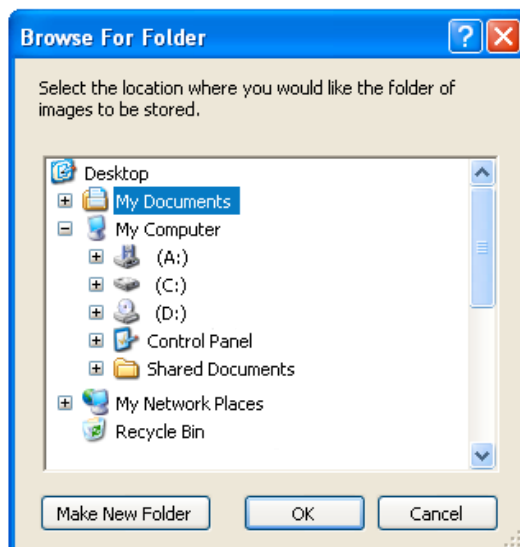

### **Please note:**

It is not possible to name each of your image files. The name of each file will be the same as its canvas name. Make sure the canvases are named appropriately before exporting.

## TRANSFER TO DOCUMENT:

---

### Transferring:

Another way to export diagrams is to transfer them to a document. This action will insert the diagrams directly into a document. You can also insert the client details along with the diagrams.

To transfer diagrams to a document perform the following steps:

1. Select the 'Transfer to Document' option from the File menu.
2. If you have multiple diagrams in your project, select which diagrams you want to transfer.
3. Decide on the client information to include with the image.
4. Deselect the checkbox to left of the information type to exclude it.
5. Click Transfer.
6. Select name and location for document and click Save.

**Transfer To Document:**

Client Name: Joe Bloggs

Client Address: Bloggs

Client Phone: (xx) xxxx xxxx

Works:

Diagram: Stair Design

Therapist Name: Mitch Hubbard

Date: 27/10/2010

Transfer Cancel Settings

**Please note:** When an image is inserted into the document it may be resized to fit on the page. This means the diagram will be in proportion but may not be to the scale that was set.

## Client Information:

The following categories are available for inclusion in the document:

Client Name	Name of client.
Client Address	Address of client.
Client Phone	Contact details for client.
Works	A description of the recommended modifications.
Diagram	A name for the diagram. The default diagram name is the canvas name.
Therapist Name	The therapist recommending the modifications.
Date	The date of the report. The default is the current date.

## Transferring Multiple Diagrams:

As with exporting pictures, if multiple diagrams are selected it is possible to transfer all those diagrams at once.

They can be transferred into a single combined document or as separate documents. Go to the Transfer Settings window to select this option.

To transfer multiple diagrams perform the following steps:

1. Decide on the client information to include with the diagrams.
2. Use the checkboxes beside each information type to determine whether it is included with the document.
3. Click Transfer.
4. If transferring as separate documents select a location for the documents and click OK.
5. Decide whether to store the documents in a new folder, enter a folder name and click Transfer All.

**Please note:**

The client details, date and therapist name will be the same on each document.

It is not possible to enter a description for the works, as this will be different for each diagram. If this option is checked it will simply provide a title for this section. The description of works can be entered via the document itself.

It is not possible to name each of the diagrams in the documents. The diagram name will be the same as its canvas name. Make sure the canvases are named appropriately before transferring.

## Transfer Settings:

There are a number of options to customise the transfer. These transfer settings can be accessed from the Format Menu or from the client information page in the Transfer to Document option.

Customise using the following settings:

---

Template	Enables the use of a document template as a base for the transferred documents. Use this option to create a specific template for your department. To select this option check the Template option and then click Browse to find and select the template. The template must be a .dot file.
----------	---

See next page for full description of how to create a template.

---

Transfer All	Under the Transfer All option individual documents can be created for each diagram or one combined document can be created with each diagram inserted on a new page. Select either the 'Multiple Documents' or 'Combined' options.
--------------	--

---

Therapists	As Therapist names are entered in the client information form, OT Draw will remember these names so you can easily use them again. In Transfer Settings view and adjust what the current therapist names are.
------------	---

---

Auto-Crop	Turn the auto-crop feature on and off to automatically crop the white space from around your diagrams.
-----------	--

---

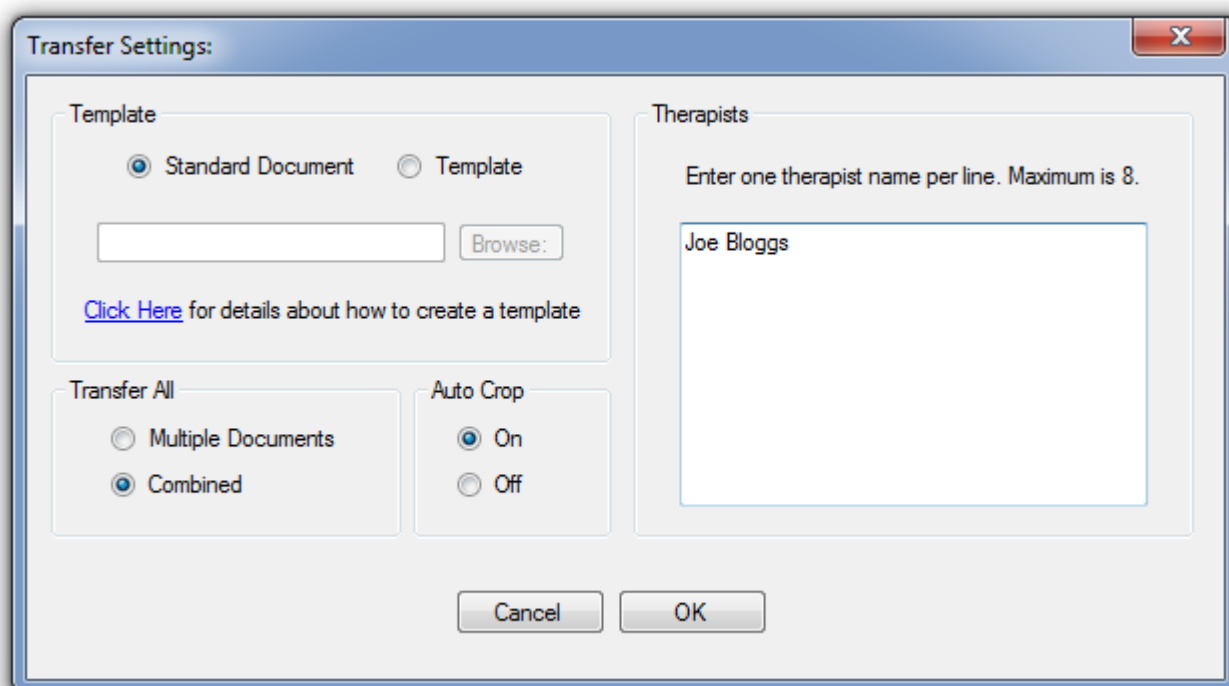

## Setting up Transfer Template:

A .dot template can be used to customise your transfer document. The template can include department details, company logo, disclaimers etc.

There are 2 methods for creating your template:

### Header / Footer:

The first option is to insert all your information in the header and footer of the template, leaving the body of the template empty.

Then OT Draw will insert all the headings and corresponding client and diagram information in the main body of the document.

### Markers:

The second option is to design the template from scratch and populate it with <markers>. OT Draw will then replace these markers with the corresponding client and diagram information.

The available <markers> are:

<b>&lt;Marker&gt;</b>	<b>Information:</b>
<Name>	Client's full name
<Address>	Client's full address
<Phone>	Client's phone number
<Works>	Written description of works
<Title>	Title of the diagram
<OT>	Name of therapist
<Date>	Today's date

Please Note: The <Diagram> marker must be present for this template option to work.

## COPY AND PASTE:

---

It is possible to copy your diagram in OT Draw and paste directly into a document or any program that will accept an image file.

Make sure nothing is selected in your diagram and then copy the image using Ctrl+C or using the copy parameter.

Then paste directly into another program.

This is a helpful technique if you have already transferred your diagrams to a document and then need to make changes to one of the diagrams.

Simply copy that one diagram and then paste into the existing document. It doesn't need to be re-transferred all over again.



## PRINTING YOUR DIAGRAMS:

---

There is an option to print diagrams straight from OT Draw.

### Print Preview:

Start the print process by selecting Print... from the File menu or by pressing Ctrl+P.

This will bring up a print preview of the current diagram. Change the diagram in the print preview by clicking the left and right arrows in the top left of the toolbar.

Use the Zoom tool to change the size of the preview.



### Print Parameters:

When the print preview is showing you can change any of the parameters in the toolbar to adjust how your diagram prints on the page. The print preview will refresh when you make any changes.

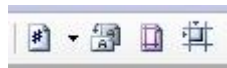

- |                   |  |
|-------------------|--|
| Page Size:        | Change to a different page size available on your default printer  |
| Page Orientation: | Change between Portrait and Landscape views  |
| Margins:          | Adjust the margins to make the diagram fit to scale on the page  |
| Page Layout:      | Change where the diagram is situated on the page (eg: top left, centre etc)  |
| Oversize:         | If the diagram is too big to fit on the page within the margins and parameters the oversize parameter will be visible. Select either 'Retain Scale' or 'Resize to fit page'. |

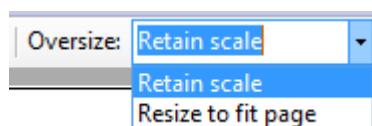

## Print and Print All:



When all parameters have been adjusted, click the Print button to print out just the current page.

To print out multiple diagrams at once, click the Print All button. This will bring up the diagram list to select which ones to print. Please note that all pages will have the same margins and parameters. If you need to adjust these parameters for each page it is best to print each diagram separately.

# Modules

This section will go through each module and how to effectively use the Module Function and Drawing Tools to create complex diagrams in minutes.

There are 6 modules in OT Draw:



**Blank Canvases**

**Bathroom Templates**

**Floorplans**

**Stair Designs**

**Ramp Designs**

**Insert Pictures**

## MODULE 1: NEW BLANK CANVAS:

---

Use this module to add a new blank canvas to your project. You can then use all the drawing tools to create a custom diagram.

## MODULE 2: BATHROOM TEMPLATES:

---

For this module there are two phases for creating the diagram:

1. Inserting a Template
2. Adding Rails and Fittings

### Phase 1: Inserting a Template:

#### STEP 1

To begin click the Bathroom Templates Module Button to insert a bathroom template onto the canvas.

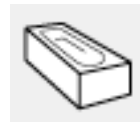

#### STEP 2

Choose from a Shower, Bath or Toilet template.

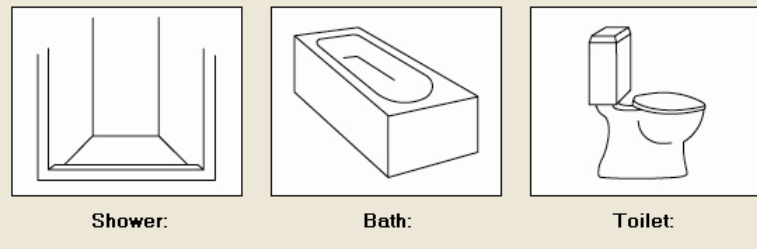

#### STEP 3

Choose a sub-type for the template that was selected. For Shower Templates choose either a Standard Shower or Cut-Out Shower and whether it does or doesn't have a hob. For Bath and Toilet Templates select the correct orientation of the template.

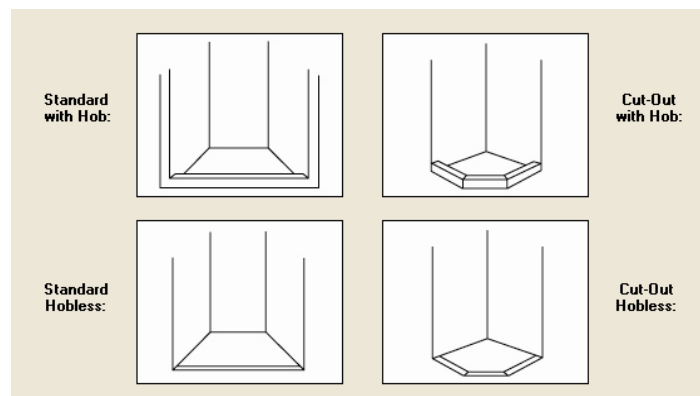

#### STEP 4

Enter the dimensions for the template. This is optional and may be left blank. This will mean that no dimensions are drawn on the template.

Enter the width and depth of the Shower template.

Enter the width, depth and height of the Bath template.

The Toilet template doesn't have this step.

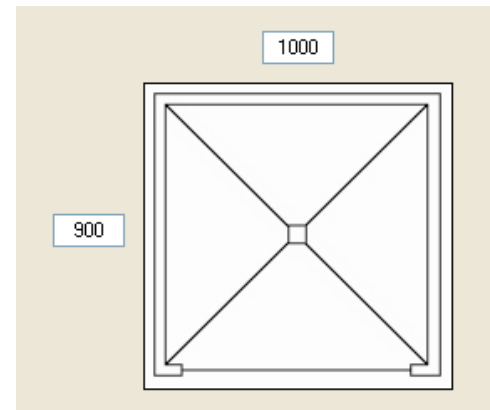

#### STEP 5

Click OK to insert the Template onto the canvas.

### Phase 2: Adding Rails and Fittings:

#### STEP 1

Double-Click on one of the template walls to automatically insert rails and fittings.

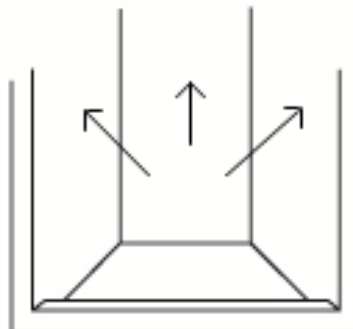

## STEP 2

A form with a number of fittings will be displayed. These fittings include:

Shower:	Bath:	Toilet:
Fixed Shower	Fixed Shower	Horizontal Rail
Hand Shower	Hand Shower	Vertical Rail
Peg for Hose	Peg for Hose	Oblique Rail
Taps	Taps	'L' Shape Rail
Horizontal Rail	Horizontal Rail	
Vertical Rail	Vertical Rail	

Click on the desired rails and fittings and click OK.



## STEP 3

Enter values for the placement of these rails and fittings. The Fixed Shower, Hand Shower and Taps will all automatically be placed on the wall at a standard position.

All the rails and the peg will require values for the placement on the wall. Enter the values and click OK for each one.

For the oblique and 'L' Shape Rail options on the Toilet template, there are 3 methods for how to insert the values. Values can be entered based on both end points or based on one end point and an angle. Scroll through the different methods by clicking the arrows on the left of the form.

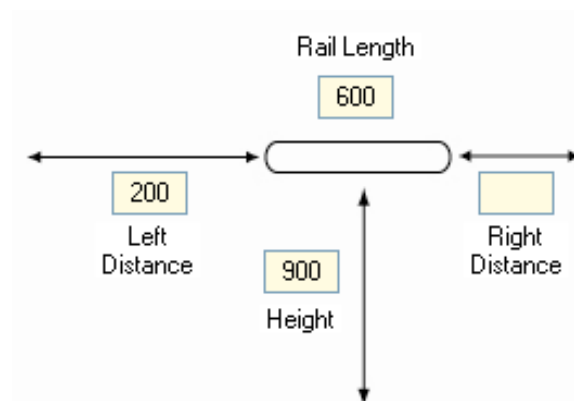

**STEP 4**

Use the Select Tool from the Drawing Toolbar and move or delete any objects on the diagram.

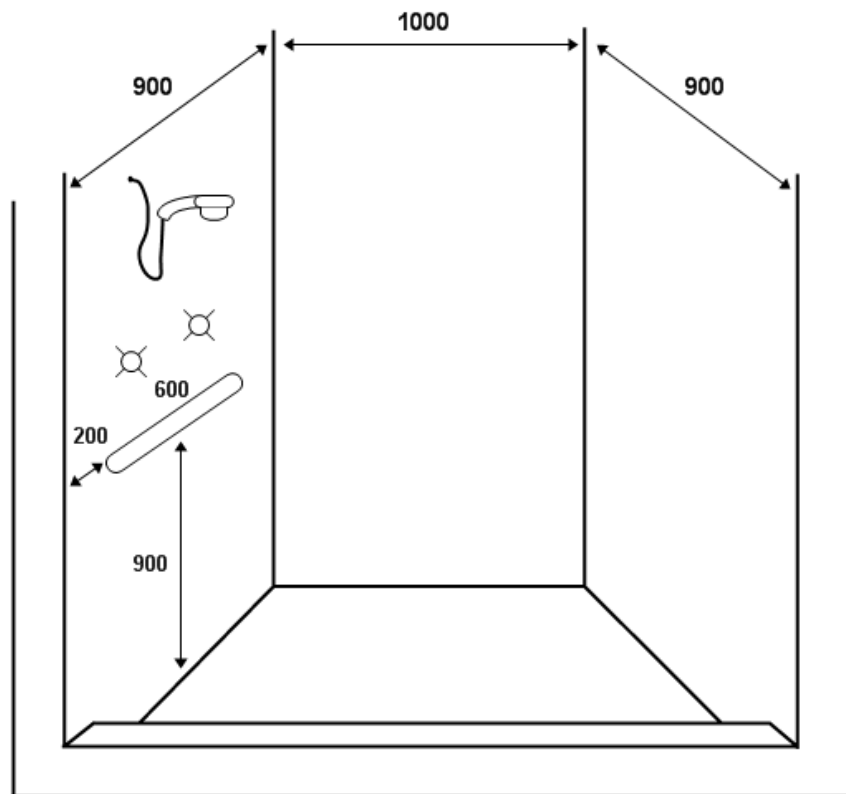
**STEP 5**

Repeat above steps for additional walls on the template that requires rails or fittings.

## MODULE 3: FLOORPLANS:

---

For this module there are 5 phases for creating the diagram:

1. Inserting a Room
2. Manually adding additional Rooms or Walls
3. Draw Bathroom or Kitchen Items
4. Draw Dimensions
5. Add Wall Labels
6. Creating Side Views

### Phase 1: Inserting a Room:

It is important to insert a room via this method and not by just drawing a rectangle as certain drawing tools and side views will not be able to be utilised.

#### STEP 1

To begin click the Bathroom Floorplans Module Button to insert a room for the bathroom floorplan.



#### STEP 2

Select either a Rectangular, L-Shape or T-Shape room. This should cover most types of bathroom shape.

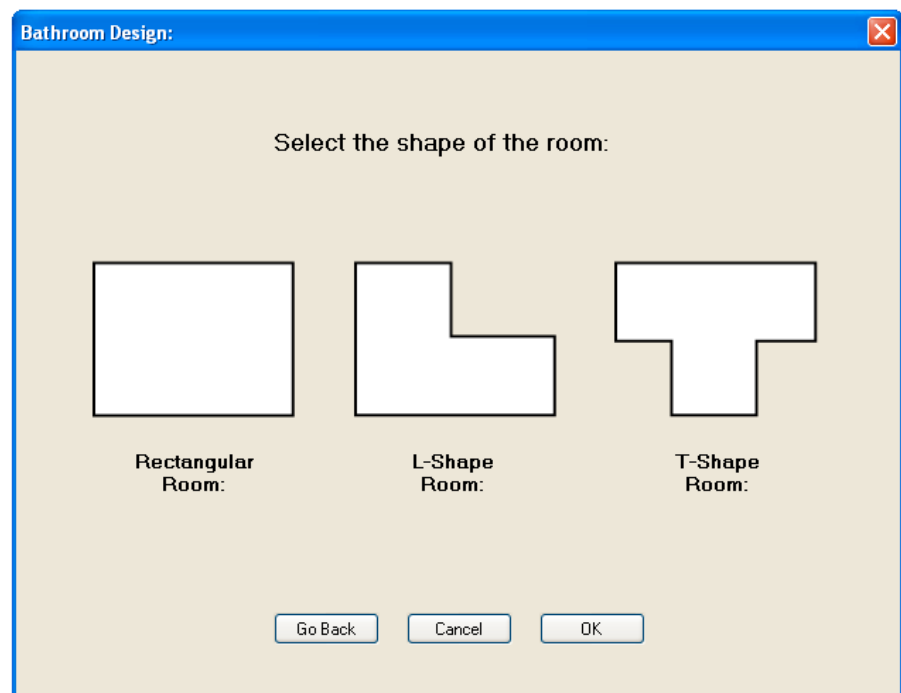



**STEP 3**

Select the correct orientation of the room. This step is only applicable for L-Shape and T-Shape designs.

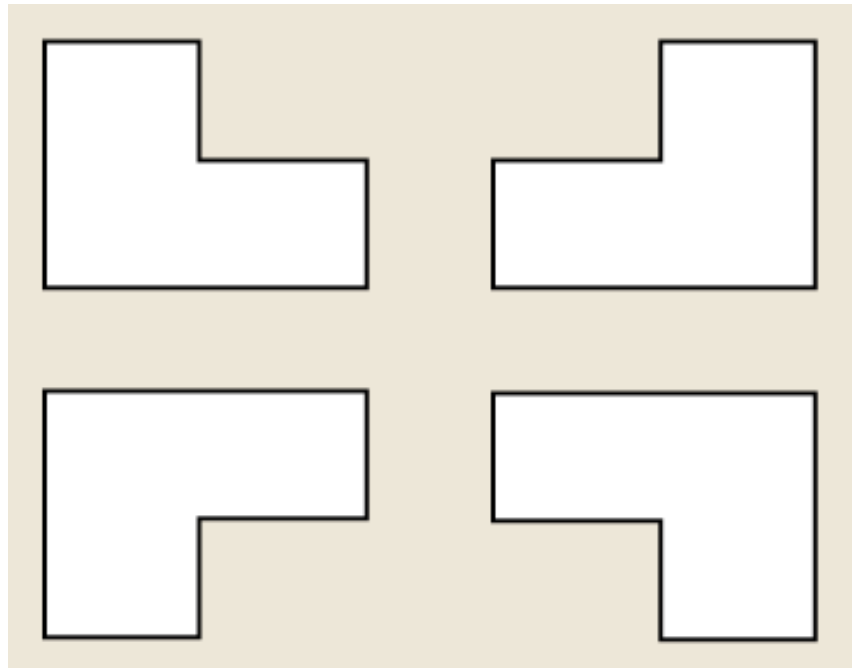
**STEP 4**

Enter the values for the room. For a rectangular shape room simply enter the width and length of the room. For L-Shape and T-Shape rooms enter the width and length and then adjust the measurements of the jut-out section of the room. Click OK to insert the room onto the canvas.

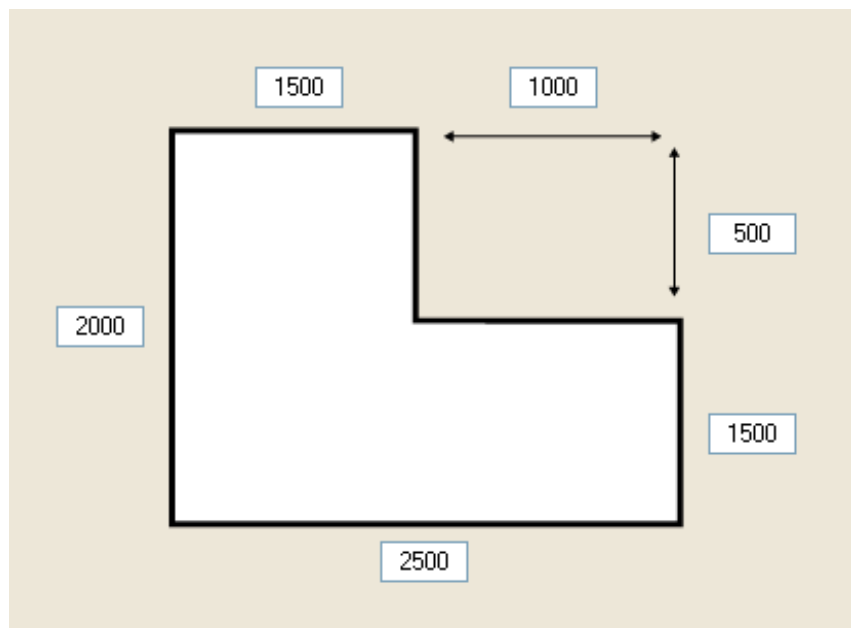

## Phase 2: Manually adding additional Rooms or Walls:



In Phase 1 you can only insert a single room. If a larger floorplan is required with multiple rooms or additional walls, the Wall Tool can be used.

This tool enables drawing of single or multiple walls.

### ***Types of Wall Objects:***

The Wall Type parameter provides the option to draw:

- Single Wall object (ie: 1 wall)
- Multiple Wall objects (ie: 2 Walls, 3 Walls, 4 Walls)
- Wall Lineshape

Single Walls are drawn as a line-based object, while Multiple Wall options are drawn as 2D objects.

The Wall Lineshape is a custom tool option that will fill in spaces the same as the wall colour. The drawing technique is the same as a standard Lineshape (See page 22 for more details)

### ***Drawing to Scale:***

For Single Walls, these are drawn like a line-based object. Enter a single value for the length of this wall section to draw to scale.

For Multiple Wall objects, these are drawn as 2D objects. To draw these to scale, enter the width, then a comma, then the height as seen on the screen. The wall object is drawn from the inside walls and the dimensions entered will reflect this.

### ***Snapping to Existing Walls:***

Wall and Room objects have 2 sorts of snapping markers. There are blue snapping markers in the corners as per normal and purple snapping markers along the edge of the wall segment.

There are also additional blue snapping markers just in from the corners. The markers are in from the corner by the wall width distance.

Use these additional markers to make your different wall objects be in line with each other.



### ***Drawing Techniques for Single Walls:***

The Single Wall object provides the most customisation for non-standard rooms. By default it will snap to completely vertical or horizontal directions.

However, there are 2 options for creating an angled Wall segment.

#### **ROTATE**

##### SHIFT KEY:

Holding down the SHIFT key will force the Single Wall segment to rotate, including the square ends.

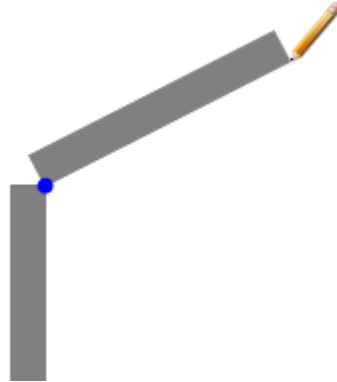

#### **SKEW**

##### CTRL KEY:

Holding down the CTRL key will force the Single Wall segment to rotate, but the ends remain in their original vertical or horizontal alignment.

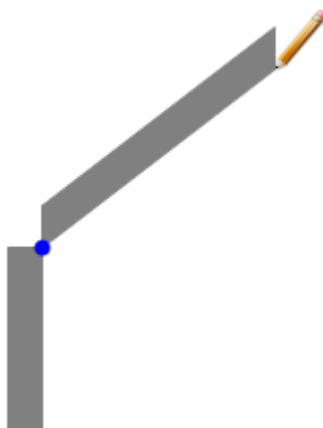

***Direction Parameter for Multiple Wall Objects:***

When adding Multiple Wall objects to the floorplan, the direction must be specified to orientate the object properly.

For 2 Wall objects, the direction is determined by the diagonal direction that the 2 walls point towards.

eg:



For 3 Wall objects, the direction is determined by the direction of the centre wall.

eg:



## Phase 3: Draw Bathroom Items:

Once the room has been inserted it's time to start drawing the different bathroom or kitchen objects.

Each tool is selected by clicking on the Toolbar button or using its corresponding shortcut. Some tools have different subtypes that you can select from.

Drawing these bathroom or kitchen objects to scale will ensure the floorplan is accurate and the layout fits in the space. See the Drawing section on page 14 for more information about drawing to scale.

### ***Drawing Techniques for Bathroom and Kitchen Objects:***

#### **Snapping**

Normally when snapping is turned on it means the cursor will snap to the end-points and corners of objects in the canvas. However, when a floorplan room is inserted it will snap with a blue dot in the corners but will also snap with a purple dot along the walls. This helps with drawing items flush against the wall. When the cursor is snapped along a wall the dimension box will display the relative distances. For instance if the wall is 2500mm wide and the cursor is at the point 800mm from the left, the dimension box will read [800, 1700] meaning it is 800mm from left and 1700mm from the right. This feature will help you position the objects accurately.

You can also move the cursor to an exact point along the wall. When the cursor is snapped to the wall with a purple dot, enter the distance you want from the nearest corner and press Enter. The cursor will now move to that location.

#### **Direction**

Nearly every bathroom object has a direction parameter that represents which way it will face on the diagram. Either set this parameter before starting to draw or press an arrow key while drawing to make the object change its direction.

#### **Tab Key**

There are a few parameters that have 2 options and can be changed with the TAB key. These include:

Shower Object: Hob / Hobless  
Toilet Object: Draw from Edge / Draw from Mid  
Door Object: Door Swing Direction

Either set this option before starting to draw or tap the TAB key while drawing to adjust the object.

### Orientation

Certain objects allow you to draw in top, front or side view (eg: toilet, basin, fridge)  
The Direction parameter is applied differently based on the which perspective it is.

### Toilet

There is a specific option for drawing the toilet either from the edge or from the middle. Drawing from the middle helps when making the toilet a certain distance from the wall to the midline. For instance to make the toilet 450mm from the wall, snap the cursor along the appropriate wall, find the distance 450mm from edge using the dimension box values, then draw the toilet using the Draw From Mid parameter.

## Phase 4: Draw Dimensions:

After adding all the relevant bathroom items to your floorplan add dimensions to the diagram. The best way to use dimensions for bathroom floorplans is to use the slide feature in the Dimension Tool. Use the following steps:

### STEP 1

Click on the Dimension tool in the Drawing Toolbar or press 'D' to select it.

### STEP 2

Draw the dimension by snapping between corner points of the room or bathroom object.

### STEP 3

If drawing by 'Click and Drag', before letting go of the mouse button, press 'D' again to slide the dimension away from the object to create dimensions around the border of the room.

## Phase 5: Add Wall Labels:

Click on the Add Wall Labels button in the canvas toolbar. This will automatically insert wall labels (eg: Wall A, Wall B etc) around the outside of your diagram.

## Phase 6: Create Side views

Once the floorplan has been completed you are able to use the powerful Create Side Views function in OT Draw. Simply perform the following steps:

### STEP 1

Click the Create Side Views Button which has now appeared in the canvas toolbar. It can also be found under the Wall Tool options.

A rectangular button with a light beige background and a thin border. On the left side, there is a small green right-pointing triangle. To the right of the triangle, the text "Create Side Views" is written in a dark grey font.

## STEP 2

Determine area of floorplan that requires the side views created. If there is only one Room/Wall element on the canvas, it will automatically jump to Step 3.

If there are multiple Room/Wall elements on the canvas, there will be a prompt to draw boundary markers on the area of the floorplan that require side views.

Click and Drag the boundary markers around the INSIDE walls of the required area.

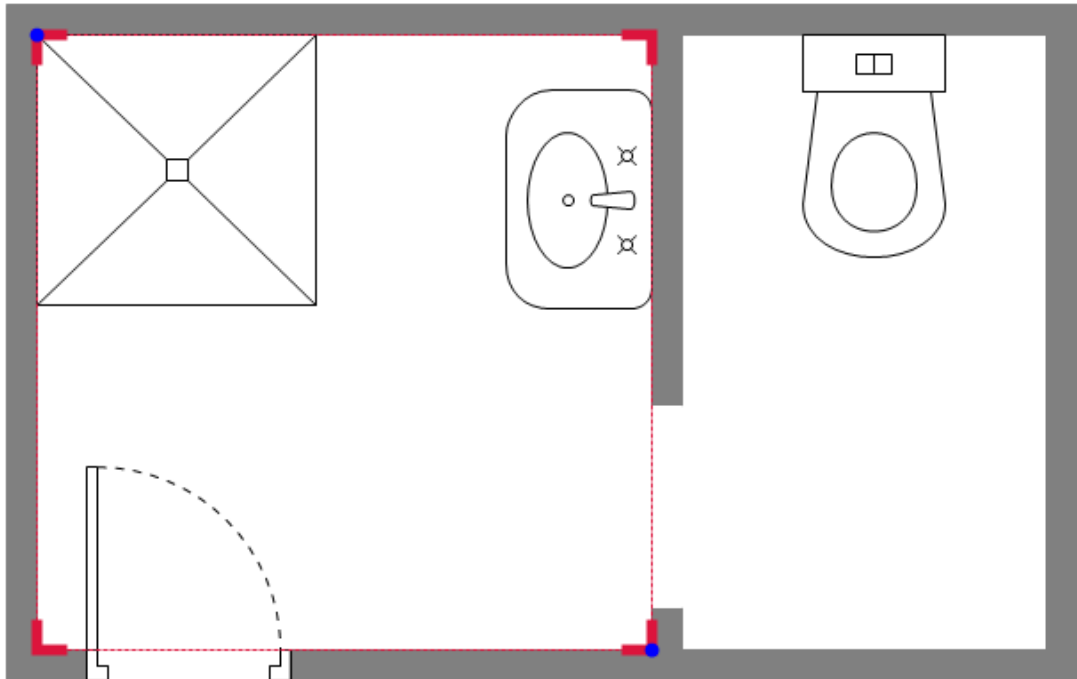

## STEP 3

Create a side view by clicking the checkbox associated with that wall. Create multiple side views by clicking multiple checkboxes.

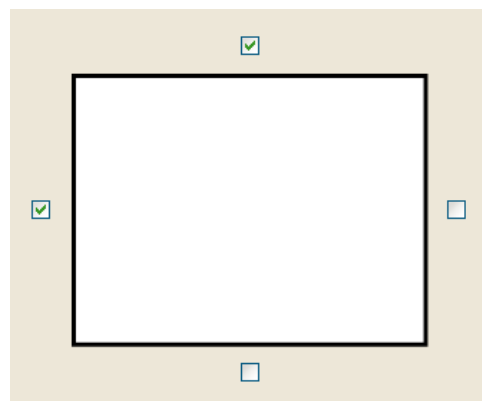

#### STEP 4

Select the desired settings for the side view:

SideView Style: The sideview can either be drawn as:  
Elevation (2D look) or Perspective (3D look).



#### STEP 5

Click OK to create your views. Additional canvas tabs will be created for your side views and will be named accordingly. Click on these tabs to access and edit these side views.

#### STEP 6

The program will automatically create side views of the bathroom objects in the floorplan. The height of these items can be altered by clicking on the item and dragging the height marker up and down.

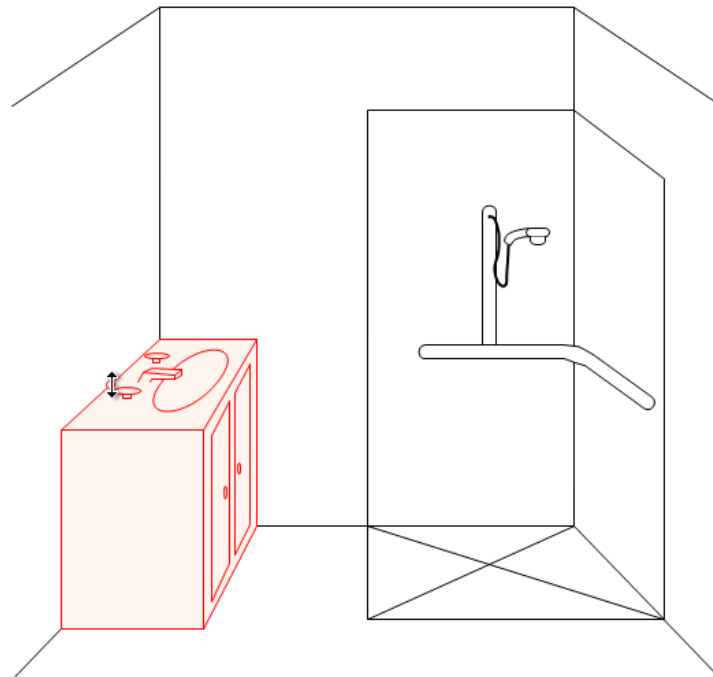

#### STEP 7

Add additional objects and fittings to the side view. Use the Rail, Arrow and Dimension drawing tools to draw and label rail locations. Use the Fittings (Alt+F) drawing tool to add shower heads, taps and shower pegs to the diagram. Use the Wall Fittings to add windows, mirrors and cabinets to the diagram.



## MODULE 4: STAIR DESIGNS

---

### START

Click the Stair Design Module button to start Stair Design process. This will bring up a design form that will set the preferences for different features of the stair diagram. There are 7 steps to complete.



### STEP 1

#### Perspective:

Determine whether diagram will have either a left or right perspective. Click on the image to select the perspective. Click Next to continue

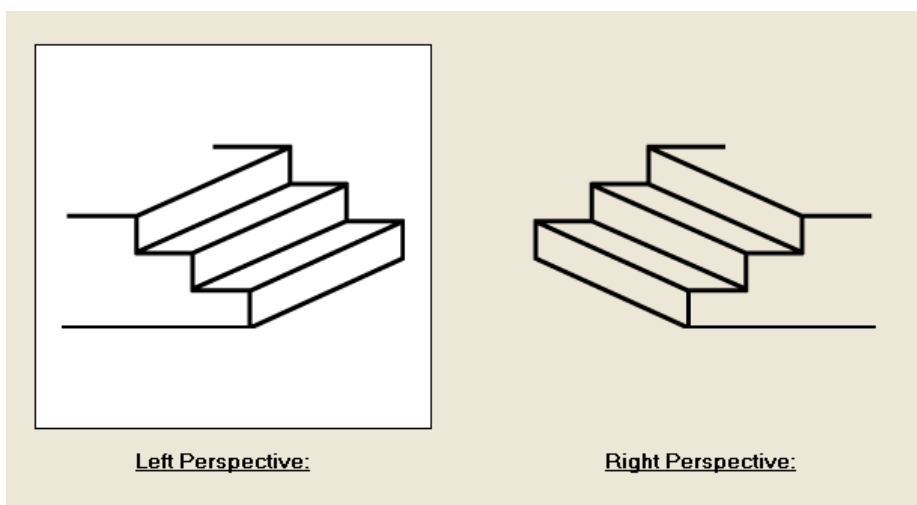

### STEP 2

#### Display Features:

Decide on the following key features of the diagram:

- No. of steps: Enter the number of steps required in the diagram. This number is determined by the number of stair rises.
- Lateral Lines: This feature can be set to either Yes or No. Entering **Yes** will draw additional lines at the sides of the steps to provide extra perspective, making it look like there is a wall along that side.
- Draw Labels: This feature can be set to either Yes or No. Entering Yes will draw the steps and all rise and tread dimensions. Entering No will draw the stairs without any rise and tread dimensions.

## Display Features: (continued)

Stair Values: This feature has 3 options for how to enter values for the rise and tread of the stairs. You have the following options:

Enter Each Value	Enter the rise and tread of every stair value.
Enter Total Lengths	Enter the total rise and tread for the set of stairs.
Standard Size Steps	Enter no values. The program will draw standard size rise and tread for the steps.

**Number of steps:**

**Draw Lateral Lines:**

**Draw Labels:**

**Stair Values:**

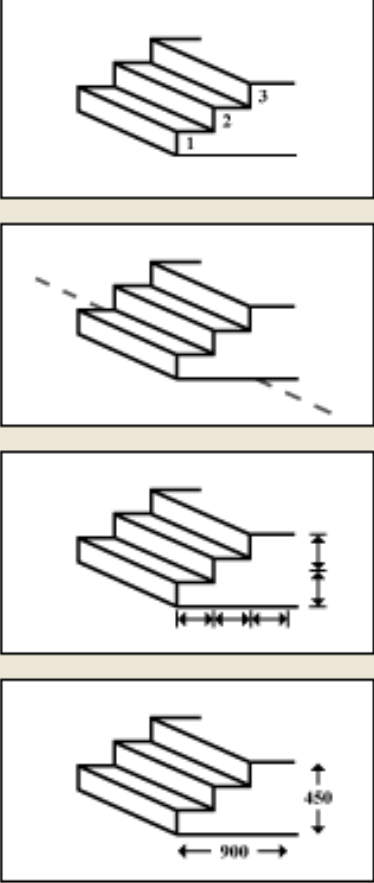

### STEP 3

#### Stair Values:

Enter the values of the rise and tread of the stairs. Based on the features set in Step 2 enter the values for each step or the total rise and height.

If the Stair Values setting in Step 2 was set to 'Standard Size Steps' then this step will be skipped.

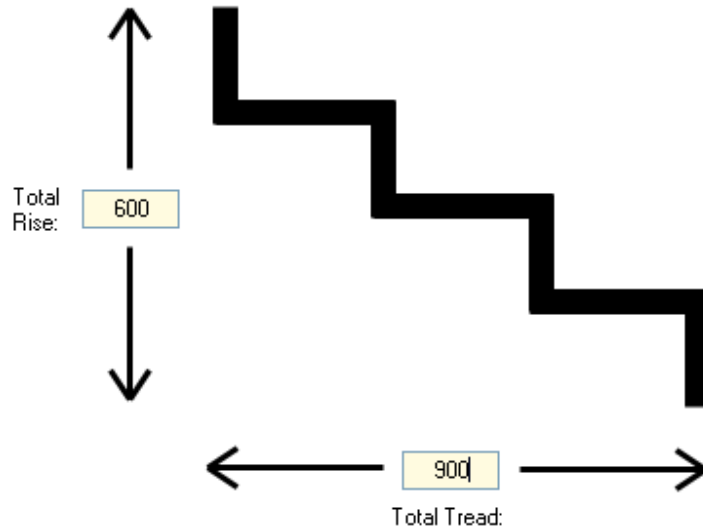

### STEP 4

#### Rail Options:

Select what type of rail, if any, is required on the diagram. Select a far side rail, a near side rail, bilateral rails or no rails at all. Click on a rail image to select it. Click an image again to deselect. Make your selection and click Next to continue.

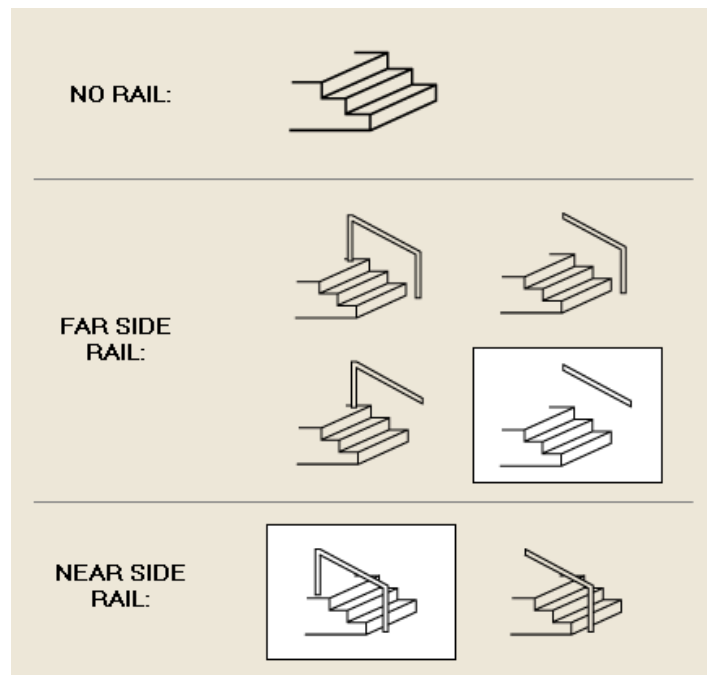

**STEP 5****Far Rail Values:**

If a far-side rail was selected in step 4 then enter the appropriate values for this rail. If a far-side rail wasn't selected then this step will be skipped. Values to be entered include:

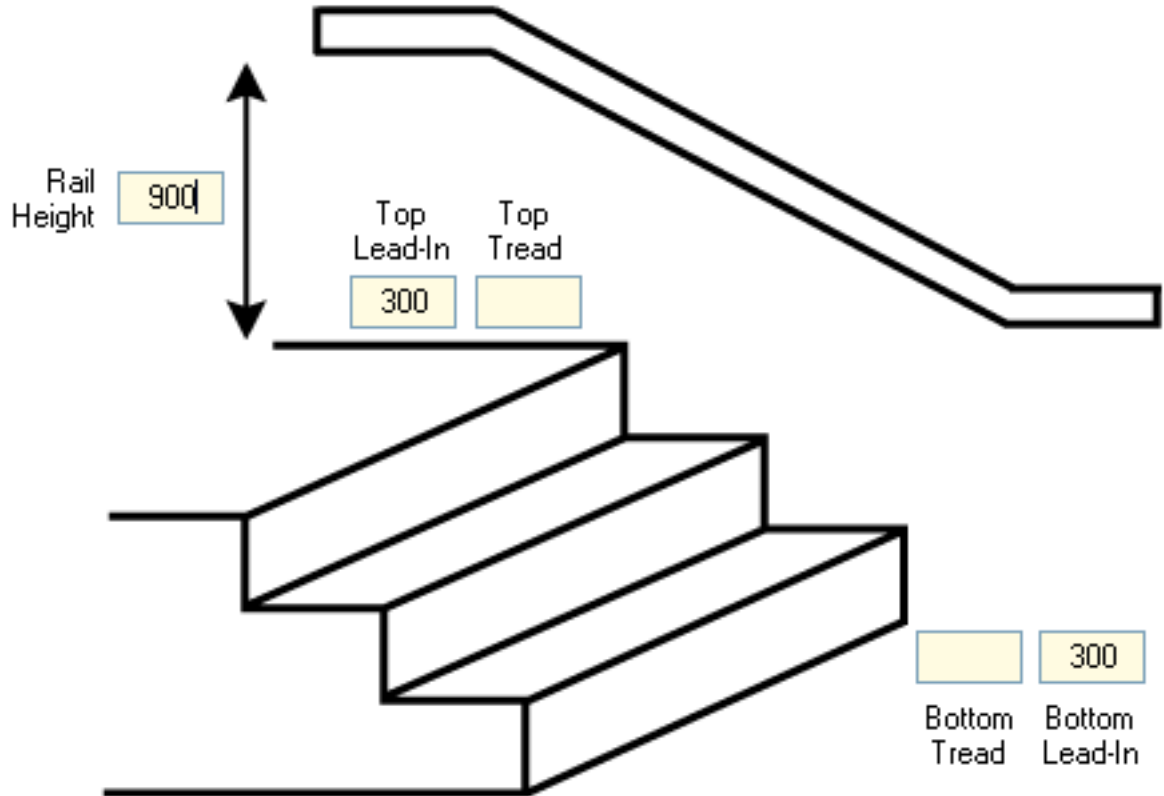

Value	Description	Special Features
Bottom Lead-In	A horizontal lead-in at the bottom of the steps.	Can be left blank. Value must be a positive number.
Bottom Tread	How far the angled rail extends past the bottom step.	Can be left blank. Value can be negative if rail is to finish before bottom step.
Top Lead-In	A horizontal lead-in at the top of the steps.	Can be left blank. Value must be a positive number.
Top Tread	How far the angled rail extends past the top step.	Can be left blank. Value can be negative if rail is to finish before top step.
Rail Height	The height of the rail from top of the steps.	Must have a value. Value must be a positive number.

Select from the following options to determine the labels to be drawn with the rail:

Label	Description
Draw all labels	Draws labels and dimensions for Rail height as well as tread and lead-in values.
Draw Height Label	Only draws the label and dimension for the rail height.
Draw No Labels	Only draws the rail without any additional labels or dimensions.

### STEP 6

#### Near Side Values:

This step is the same as Step 5 but for the near side rail. Enter the values for lead-in, tread and rail height for this rail. Select what labels you want drawn with the rail.

If a near-side rail wasn't selected then this step will be skipped. If values were entered for a far-side rail in step 5 then these values will be carried over. Edit these to have different values if required.

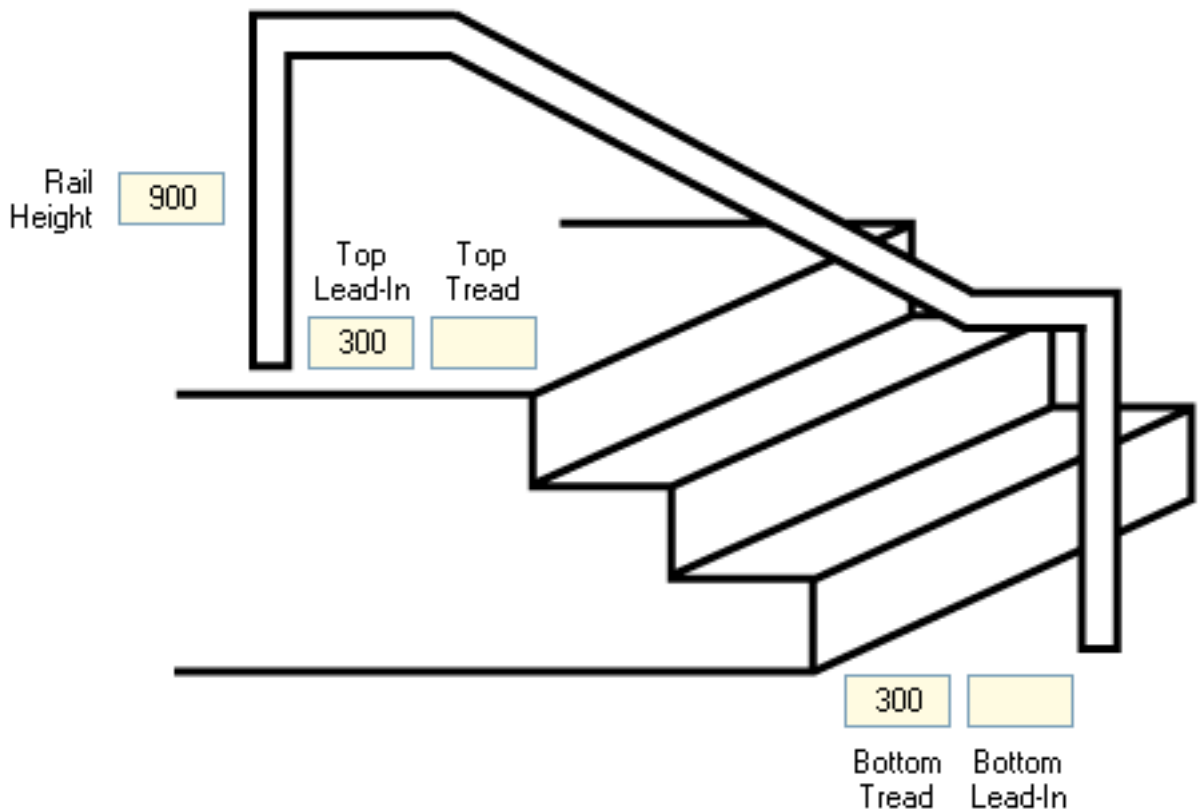

## STEP 7

### Design:

This is final step before the stair diagram will be drawn. Check all the values are correct before continuing. If any compulsory values are empty you'll be asked to amend this before completing the diagram.

Click Draw Stairs to complete the form and draw the stair diagram to the canvas.

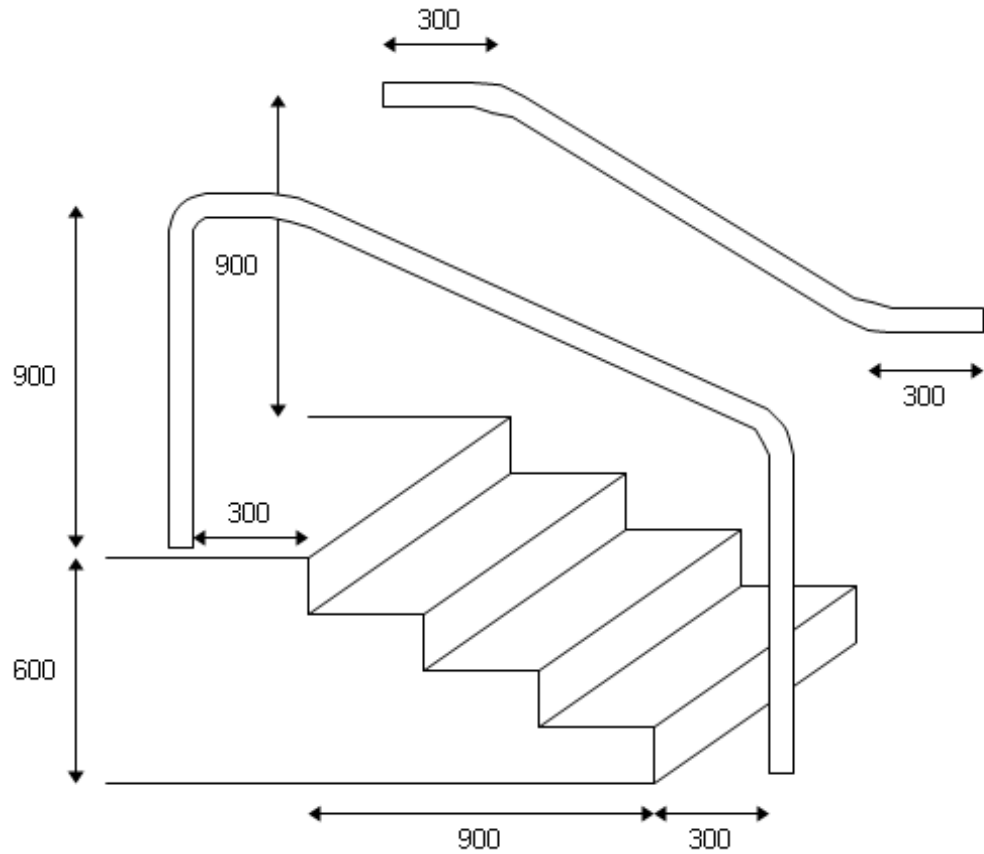

## MODULE 5: RAMP DESIGNS:

### START

Click the Ramp Design Module button to start the Ramp Design process. This will bring up a design form that will set the preferences for different features of the ramp diagram. There are 6 steps to complete.

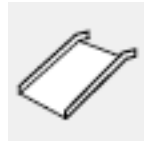

### STEP 1

#### Ramp Type:

Determine the type of ramp required in the diagram and click on the image to select it. Select from the following options:

Type	Description
Single Ramp	One straight ramp.
Double Ramp - Straight	Two ramp sections that continue in 1 straight line.
Double Ramp - Corner	Two ramps sections 90° or perpendicular to each other.
Double Ramp - Parallel	Two ramp sections 180° or parallel to each other.

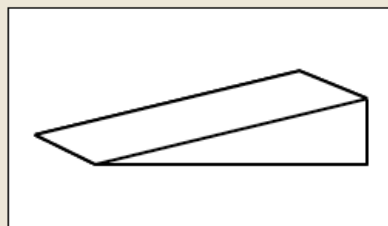

Single Ramp:



Double Ramp - Straight:

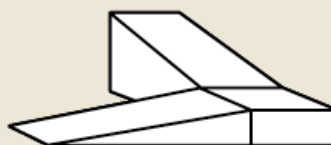

Double Ramp - Corner:



Double Ramp - Parallel:

## STEP 2

### Perspective:

Determine whether the diagram is to have either a left or right perspective. Click on the image to select the required perspective.

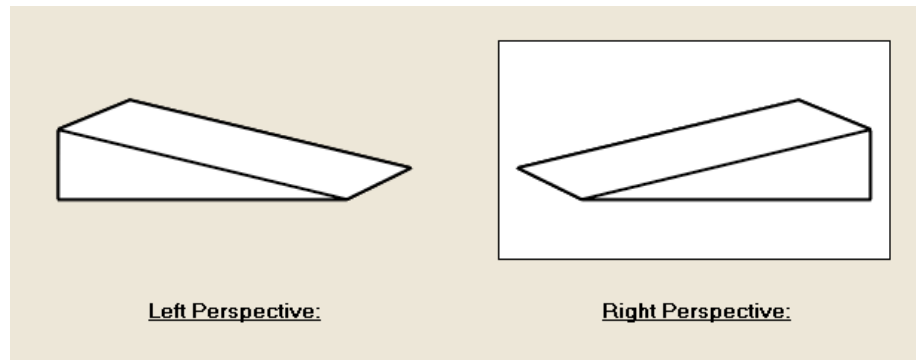

## STEP 3

### Ramp Values:

Enter values for the width, length and height of the ramp.

If drawing a double ramp, this section will appear twice, one for each section of ramp. The first ramp is the lower section and the second ramp is the upper section.

Determine the gradient of the ramp through the values entered for the length and height values. For instance if the ramp gradient is to be 1:14 and the ramp length is 3000mm (or 3m) then calculate the ramp height to be 215mm ( $3000\text{mm}/14$ ) and enter this into the height value.

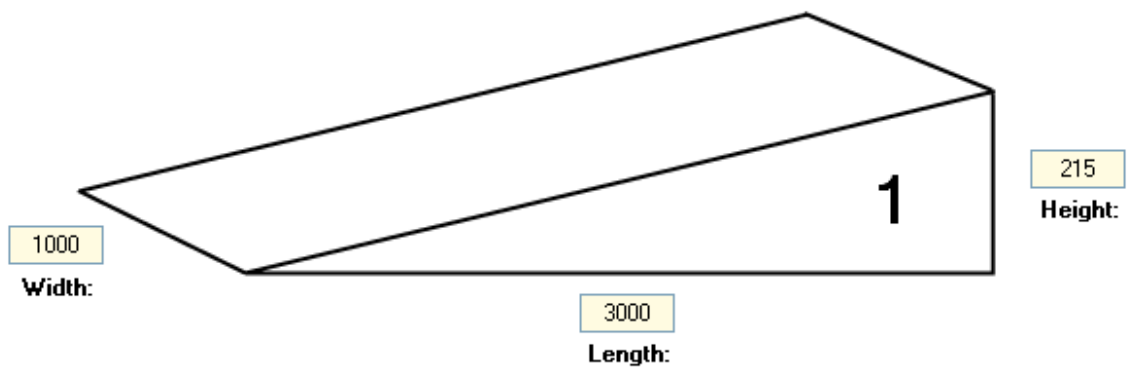



## STEP 4

### Landings:

If drawing a single ramp, enter the details for a bottom and top landing. If drawing a double ramp, enter details for a bottom, top and middle landing.

The bottom and top landings are optional but the middle landing is required.

Include landing

If it is a bottom or top landing, determine if diagram is to include this landing. Uncheck the box below the image to exclude it.

Enter Landing Values

Enter values for the width and length of the landing. By default they will be the width of the ramp that was specified.

Enter Offset Values

If these values are set to 0 the landing width will be the same as the ramp. If the landing width is larger than the ramp, use these offset values to determine how much the landing will spill out on each side.

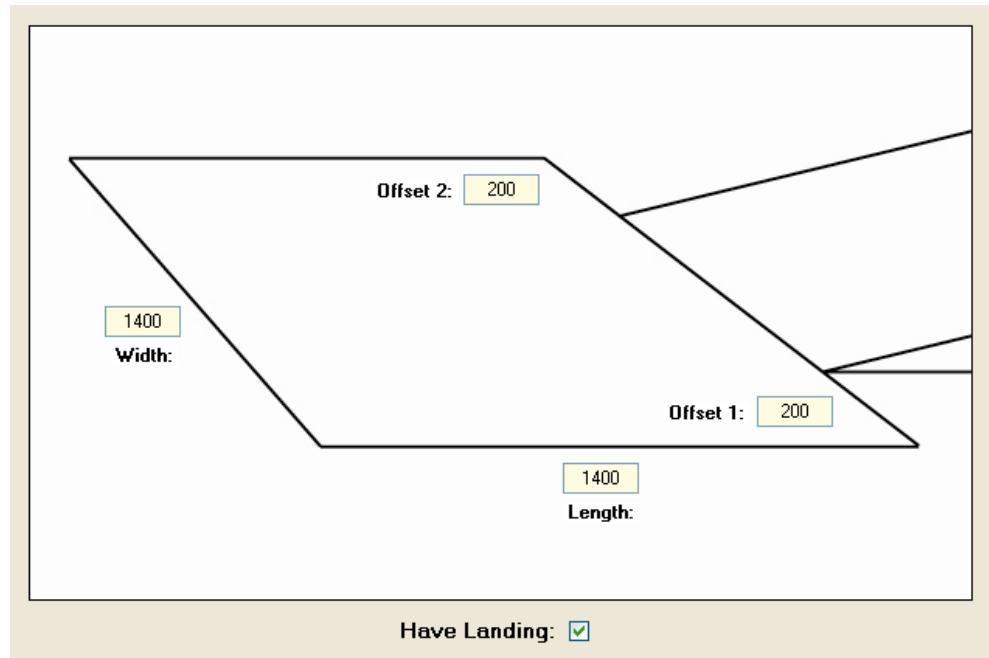

## STEP 5

### Rail Options:

This feature is only enabled for single ramps. Select the type of rail required and then enter the values for the far-side and near-side rails that were selected.

This feature is the same as the stair design process. See the Module: Stair Design section on page 61 for more details about how to enter values and features for these rails.

## STEP 6

### Draw Ramp:

This is final step before the ramp diagram will be complete. Check all the values are correct before continuing. If any compulsory values are empty you'll be asked to amend this before completing the diagram.

This design form can draw the ramp in 2 forms: Top View and 3D View. Top View will draw the ramp as a plan, including all width and length measurements but won't include any height measurements. 3D View will draw the ramp with a 3D perspective and will only draw the height and rail measurements. Select Top View, 3D View or both.

Click Draw Ramp to complete your form and draw the ramp diagram to the canvas.

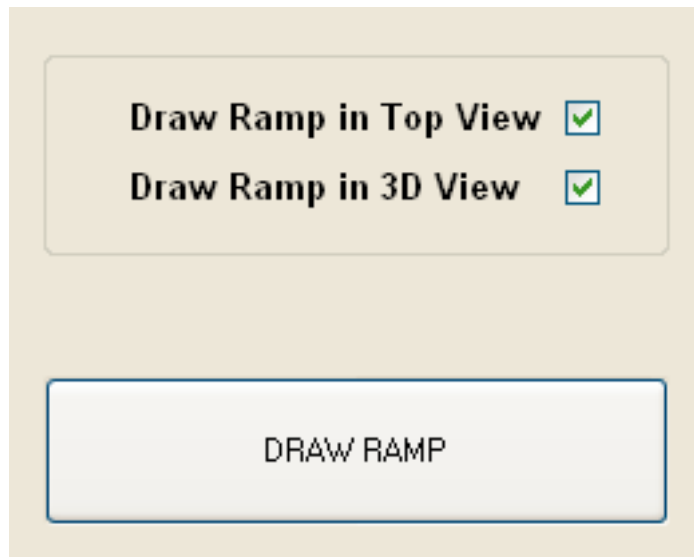

The screenshot shows a software interface for drawing a ramp. It features two checked options: "Draw Ramp in Top View" and "Draw Ramp in 3D View", each with a green checkmark in a small box. Below these options is a large, light gray button with a blue border labeled "DRAW RAMP".

## MODULE 6: INSERT PHOTO:

---

The purpose of this module is to insert pictures, photos or images into the project and then draw straight onto these pictures.



### Phase 1: Insert the Picture

Click the Photo Module Button to insert a picture. A popup option will appear to determine how to insert the photo.

The picture can be inserted by locating the filepath of the photo. This option will then open a dialog box to open the saved picture. Find the saved picture and click Open.

If the picture has been copied to the Clipboard, the Pasting from Clipboard option can be selected to avoid needing to find the filepath.

The picture can be inserted on to a brand new canvas as a starting point, or multiple pictures can be inserted on to the same canvas.

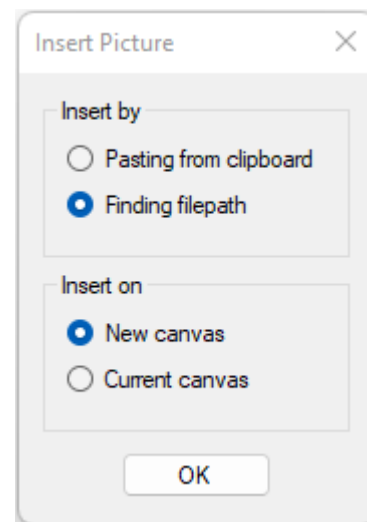

### Phase 2: Adjust the Picture

**Auto-Resize:** If the picture is larger than the canvas you'll be asked if you want to automatically resize the image. This will mean the picture will fit within the canvas when scaled to 100%.

**Rotate Image:** Rotate the picture clockwise by using then Select Tool, then right-clicking the picture and selecting either Rotate 90°, 180° or 270°.

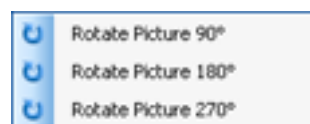

### Phase 3: Selecting the Picture

The picture can be selected like any other object to move, resize, copy etc. However to select the picture, the outside border needs to be clicked rather than the centre of the photo. This is to avoid unintended selection when using other tools.

## Phase 4: Draw to scale on the Picture

After the picture is inserted, use any of the drawing tools to draw rails, shapes, dimensions, arrows and labels on the diagram. Pressing Clear Canvas will only clear these objects with the background picture remaining. Pressing Clear Canvas again will remove the picture as well.

The Scale Factor for this diagram will have changed to a percentage since it's impossible to know the size and scale of whatever is in the picture.

However it is possible to set a relative scale for the picture. To do this, select the Measure Tool and measure something in the picture that you know an exact measurement of (eg: the height of a step). Enter this value in the Dimension Box and press enter. The scale is now set to this ratio.

***Please note:***

This is not an exact scale as the picture will have varying depths which affect the true scale of that part of the picture. However it will make the scale more comparable.

### Tips for drawing on photos:

The following tool tips are useful for drawing on photos:

- Use LineShapes to draw ramps and platform steps on photos  
See page 22 for details on how to draw LineShapes.
- Select Text and put 'Fill' (by clicking Fill parameter checkbox) to insert a background behind the text. This contrast helps to read the text.
- Change width and colour of lines and dimensions to make them clearer and contrast with the colours of the photo.

## INSTALL AND ACTIVATE OT DRAW:

---

Perform the following steps to install, purchase and activate OT Draw on your computer.

### 1. Install OT Draw:

Install OT Draw by downloading it from [www.otdraw.com/download](http://www.otdraw.com/download) or by using an Install Disc. The installer will prompt you to install Microsoft .Net Framework 3.5 software if required. Most latest versions of Windows already have this Framework installed.

OT Draw has a trial period of 14 days, after which you need to purchase a license and activate OT Draw to continue using it.

### 2. Purchase a license to use OT Draw:

Contact our sales team at [sales@otdraw.com](mailto:sales@otdraw.com) or visit our website to purchase a license. A license needs to be purchased for each computer that OT Draw will be installed on.

After purchasing a license you will be given a LicenseID and Activation Password. Use these to activate the software.

### 3. Activate OT Draw:

To activate OT Draw, run the program, click Activate and then enter your LicenseID and Activation Password. The system will then activate the software for your computer.

## AUTOMATIC UPDATES:

---

### Auto-Update Feature:

OT Draw will automatically check to see if there are updated versions of OT Draw available to download and install. There needs to be an internet connection for this to occur.

If you have a subscription license or active maintenance support then you will be able to download and install OT Draw free of charge. Otherwise, for major updates, there will be a cost to purchase an upgrade.

Installing updates will fix bugs, include new features and overall improve efficiency.

Manually check for updates at any time by using the 'Check For Updates' option in the Help menu.

## SUPPORT INFORMATION:

---

For further support contact us at [support@otdraw.com](mailto:support@otdraw.com) or visit the support page on our website [www.otdraw.com/support](http://www.otdraw.com/support).

These links can be accessed from OT Draw by going to the help menu and selecting either the Email Support or Online Support options.

The Help menu also contains links to the Tutorial Videos, User Manual, Tips and Tricks, Keyboard Shortcuts and other materials to help you get the most out of OT Draw.

Enjoy using OT Draw.

